

THIS IS A C.A.D. GENERATED DRAWING
DO NOT MAKE MANUAL REVISIONS TO MASTER.

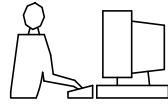

* UNLESS OTHERWISE SPECIFIED TOLERANCES
ON DECIMAL IS: ANGLE
UNIT: MM X.
X.X

ISSUE NUMBER



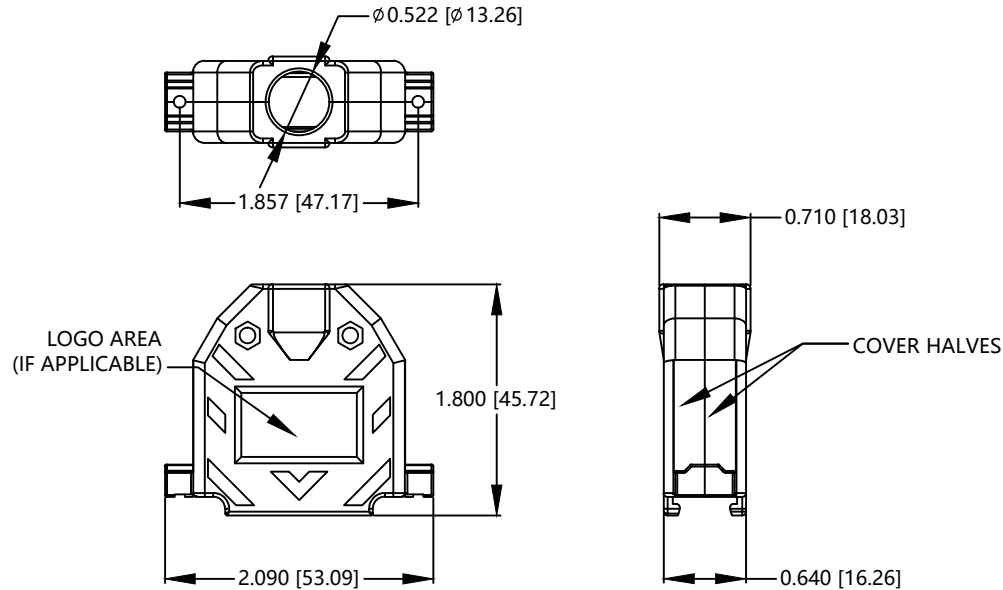

ORIGINAL ①

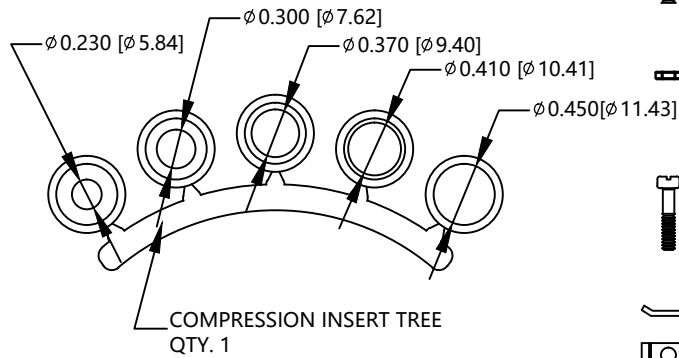

PART NUMBER INFORMATION

PART#	LOGO STYLE	SUPPLIED
C88E320000	NO LOGO	PACKAGED



-  #4-40 X 7/16" FILLISTER HEAD MACHINE SCREW
MATERIAL - STEEL
FINISH - BRIGHT ZINC (HEXAVALENT CHROMIUM FREE)
QTY: 2 EACH
-  #4-40 #2 BLANK HEX NUT
MATERIAL - STEEL
FINISH - BRIGHT ZINC (HEXAVALENT CHROMIUM FREE)
QTY: 2 EACH
-  #4-40 x 1/2" FILLISTER HEAD CAPTIVE SCREW
MATERIAL - STEEL
FINISH - BRIGHT ZINC (HEXAVALENT CHROMIUM FREE)
QTY: 2 EACH
-  #4 SADDLE WASHER
MATERIAL - STEEL
FINISH - BRIGHT ZINC (HEXAVALENT CHROMIUM FREE)
QTY: 2 EACH

CONNECTOR COVER:

1. MATERIAL : ABS COMPOUND - UL94HB
2. FINISH : NICKEL PLATING PER NTC SPECIFICATION N/T 000500
3. DIMENSIONS : INCHES [MM]
4. TOLERANCE : ±0.015 [0.381]

COMPRESSION INSERT TREE

1. MATERIAL : THERMOPLASTIC
2. COLOR : BLACK
3. DUROMETER: 75±5 TYPE A PER ASTM D2240
4. DIMENSIONS : INCHES [MM]
5. TOLERANCE : ±0.020 [0.508]

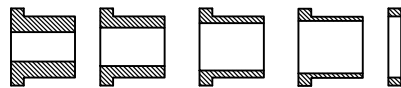

THESE DRAWINGS AND SPECIFICATIONS ARE THE PROPERTY OF MH CONNECTORS AND SHALL NOT BE REPRODUCED, COPIED OR USED AS THE BASIS FOR THE MANUFACTURE OR SALE OF APPARATUS WITHOUT WRITTEN PERMISSION.

DRAWN Henry Pan	DATE 2023/02/27
--------------------	--------------------

APPROVED	DATE
----------	------

SCALE 1:1	SHEET OF 1 OF 1	REV: 1
--------------	--------------------	-----------

DRAWING No MHC88E320000



THIS SERIES FULLY CONFORMS TO THE EUROPEAN UNION DIRECTIVES 2015/863/EU AND 2011/65/EU FOR RoHS COMPLIANCY.



**MH CONNECTORS,
DIVISION OF EDAC**