

THIS IS A C.A.D. GENERATED DRAWING
DO NOT MAKE MANUAL REVISIONS TO MASTER.

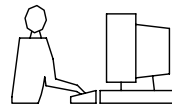

* UNLESS OTHERWISE SPECIFIED TOLERANCES
ON DECIMAL IS: ANGLE ± 1°
UNIT: MM
.X ± 0.30
.XX ± 0.20
.XXX ± 0.10

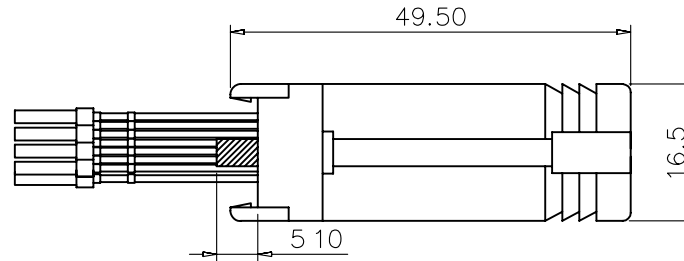
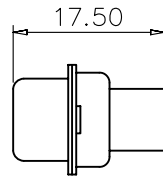

POSITION	COLOUR
1	
2	Blue
3	Orange
4	Black
5	Red
6	Green
7	Yellow
8	Brown
9	White
10	

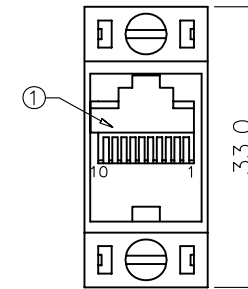
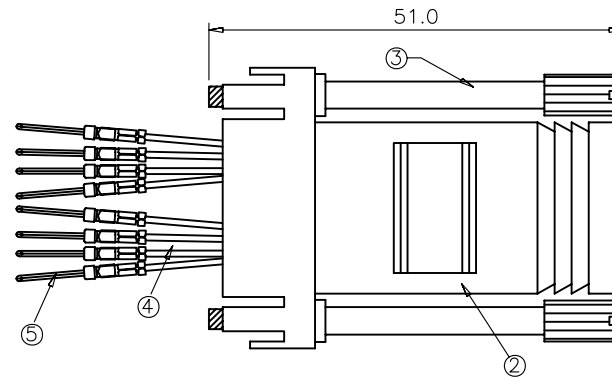
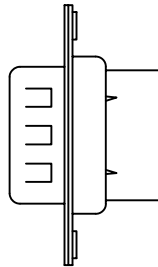
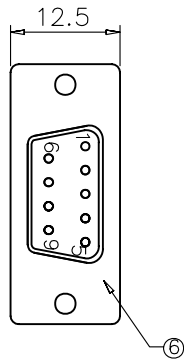

ORDERING INFORMATION:

PRODUCT CODE	COLOUR
MHDA09-PMJ8-BK-K	BLACK
MHDA09-PMJ8-B-K	BLUE
MHDA09-PMJ8-G-K	GREEN
MHDA09-PMJ8-R-K	RED
MHDA09-PMJ8-Y-K	YELLOW
MHDA09-PMJ8-LG-K	LIGHT GREY

ROHS Compliant

NO.	Name	Description	Q'ty
1	Conn	Modular jack 10P8C Male,ABS,Gray,Gold Flash Contact	1
2	Hood	ABS,Gray,Black,Blue,Green,Red,Yellow,Light Grey	1
3	Screw	#4-40UNC Thumb Screw Nickel Plated	2
4	Wire	UL1061,26AWG,7 Stand Lead Wire	8
5	Terminal	D-SUB Male Terminal,Copper,Gold Plated	8
6	Conn	Crimp Wire D-SUB Male 9pin Black Insulator	1

THESE DRAWINGS AND SPECIFICATIONS ARE THE PROPERTY OF MH CONNECTORS LTD. AND SHALL NOT BE REPRODUCED, COPIED OR USED AS THE BASIS FOR THE MANUFACTURE OR SALE OF APPARATUS WITHOUT WRITTEN PERMISSION.

DRAWN Johnny		DATE 07-10-13	
APPROVED		DATE	
SCALE	SHEET OF 1 OF 1	REV: 3.0	
DRAWING No MHDA09-PMJ8-XX-K			



THIS SERIES FULLY CONFORMS TO THE EUROPEAN UNION DIRECTIVES 2002/95/EC AND 2002/96/EC FOR RoHS COMPLIANCY.



MH CONNECTORS LTD.