

NuTiny-SDK-NUC200 User Manual

for NuMicro™ NUC200 Series

The information described in this document is the exclusive intellectual property of Nuvoton Technology Corporation and shall not be reproduced without permission from Nuvoton.

Nuvoton is providing this document only for reference purposes of NuMicro™ microcontroller based system design. Nuvoton assumes no responsibility for errors or omissions.

All data and specifications are subject to change without notice.

For additional information or questions, please contact: Nuvoton Technology Corporation.

Table of Contents

1	Overview.....	3
2	Introduction to NuTiny-SDK-NUC200	4
2.1	NuTiny-SDK-NUC200 Jumper Description.....	5
2.2	Pin Assignment for Extended Connectors	6
2.3	NuTiny-SDK-NUC200 PCB Placement.....	7
3	Starting to Use NuTiny -SDK-NUC200 on the Keil μ Vision [®] IDE	8
3.1	Downloading and Installing Keil μ Vision [®] IDE Software	8
3.2	Downloading and Installing Nuvoton Nu-Link Driver	8
3.3	Hardware Setup.....	8
3.4	Smpl_NuTiny-NUC200 Program	9
4	Starting to Use NuTiny-SDK-NUC200 on the IAR Embedded Workbench ..	10
4.1	Downloading and Installing IAR Embedded Workbench Software.....	10
4.2	Downloading and Installing Nuvoton Nu-Link Driver	10
4.3	Hardware Setup.....	10
4.4	Smpl_NuTiny-NUC200 Program	11
5	NuTiny-EVB-NUC200 Schematics	12
6	Downloading NuMicro [™] Related Files from Nuvoton Website	13
6.1	Downloading NuMicro [™] Keil μ Vision [®] IDE Driver	13
6.2	Downloading NuMicro [™] IAR EWARM Driver	14
6.3	Downloading NuMicro [™] NUC200 series BSP Software Library	15
7	Revision History	16

1 Overview

The NuTiny-SDK-NUC200 is a specific development tool for the NuMicro NUC200 series users to develop and verify the application program easily. The NuTiny-SDK-NUC200 includes two portions: NuTiny-EVB-NUC200 (an evaluation board) and Nu-Link-Me (its Debug Adaptor), such that users do not need additional ICE or debug equipment.

2 Introduction to NuTiny-SDK-NUC200

The NuTiny-SDK-NUC200 uses the NUC200VE3AN as the target microcontroller. Figure 2-1 shows the NuTiny-SDK-NUC200 for NUC200 series, in which the left portion is called NuTiny-EVB-NUC200 and the right portion is called Nu-Link-Me. ...

The NuTiny-EVB-NUC200 is similar to other development boards, by which users can develop and verify applications to emulate the real behavior. The on board chip covers NUC200 series features. The NuTiny-EVB-NUC200 can be a real system controller to design the users' target systems.

The Nu-Link-Me is a Debug Adaptor, which connects your PC's USB port to a target system (via Serial Wired Debug Port) and allows you to program and debug embedded programs on the target hardware. To use the Nu-Link-Me Debug adaptor with IAR or Keil, please refer to "Nuvoton NuMicro™ IAR ICE Driver User Manual" or "Nuvoton NuMicro™ Keil ICE Driver User Manual" for details. The two documents will be stored in the local hard disk when each is installed.

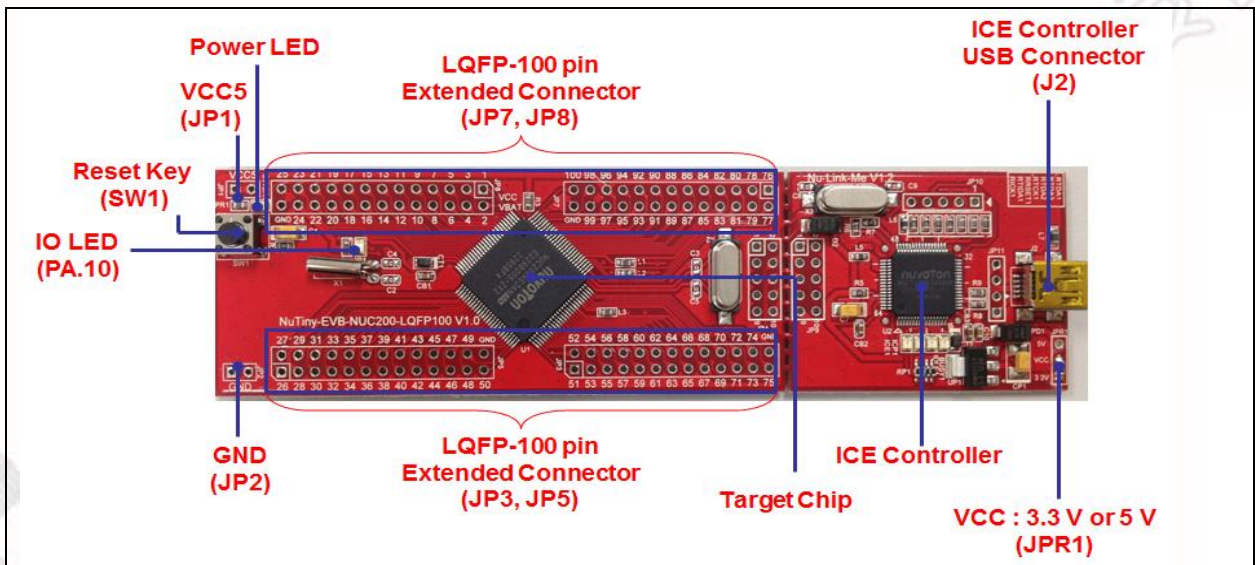

Figure 2-1 NuTiny-SDK-NUC200 (Red PCB Board)

2.1 NuTiny-SDK-NUC200 Jumper Description

2.1.1 Power Settings

- **JP1**: VCC5 Voltage connector in NuTiny-EVB-NUC200
- **J2**: USB port in Nu-Link-Me
- **JPR1**: Select 5V or 3V for system power

Model	J2 USB Port	JP1 VDD5	MCU Voltage
Model 1	Connect to PC	DC 3.3V output	DC 3.3V
Model 2	X	DC 5V output	DC 5V
Model 3	X	DC 2.8-5.5V input	Voltage by VCC input

X: Unused.

2.1.2 Debug Connectors

- **JP4**: Connector in target board (NuTiny-EVB-NUC200) for connecting with Nuvoton ICE adaptor (Nu-Link-Me)
- **JP9** Connector in ICE adaptor (Nu-Link-Me) for connecting with a target board (e.g. NuTiny-EVB-NUC200)

2.1.3 USB Connectors

- **J2**: Mini USB Connector in Nu-Link-Me connected to a PC USB port

2.1.4 Extended Connectors

- **JP3, JP5, JP7** and **JP8**: Show all chip pins in NuTiny-EVB-NUC200

2.1.5 Buttons

- **SW1**: Reset button in NuTiny-EVB-NUC200

2.1.6 Power Connectors

- **JP2**: VDD33 connector in NuTiny-EVB-NUC200
- **JP3**: GND connector in NuTiny-EVB-NUC200

2.1.7 Power Jumpers

- **JP1**: VCC connector in NuTiny-EVB-NUC200
- **JP2**: GND connector in NuTiny-EVB-NUC200

2.2 Pin Assignment for Extended Connectors

The NuTiny-EVB-NUC200 provides the NUC200KE3BN target chip on board and the extended connectors (**JP3, JP5, JP7 and JP8**) for LQFP100-pin

Pin	Pin Name	Pin	Pin Name	Pin	Pin Name	Pin	Pin Name
01	PE15	26	PE12	51	PE4	76	PA5
02	PE14	27	PE11	52	PE3	77	PA6
03	PE13	28	PE10	53	PE2	78	PA7
04	PB14	29	PE9	54	PE1	79	Vref
05	PB13	30	PE8	55	PE0	80	AVDD
06	VBAT	31	PE7	56	PC13	81	PD0
07	X32O	32	PB0	57	PC12	82	PD1
08	X32I	33	PB1	58	PC11	83	PD2
09	PA11	34	PB2	59	PC10	84	PD3
10	PA10	35	PB3	60	PC9	85	PD4
11	PA9	36	PD6	61	PC8	86	PD5
12	PA8	37	PD7	62	PA15	87	PC7
13	PD8	38	PD14	63	PA14	88	PC6
14	PD9	39	PD15	64	PA13	89	PC15
15	PD10	40	PC5	65	PA12	90	PC14
16	PD11	41	PC4	66	ICE_DAT	91	PB15
17	PD12	42	PC3	67	ICE_CK	92	XT1_Out
18	PD13	43	PC2	68	VDD	93	XT1_In
19	PB4	44	PC1	69	VSS	94	/RESET
20	PB5	45	PC0	70	AVSS	95	VSS
21	PB6	46	PE6	71	PA0	96	VDD
22	PB7	47	PE5	72	PA1	97	PS2DAT
23	LDO	48	PB11	73	PA2	98	PS2CLK
24	VDD	49	PB10	74	PA3	99	PVSS
25	VSS	50	PB9	75	PA4	10	PB8

Table 2-1 NUC200VE3AN LQFP 100-pin Assignment for Extended Connectors

2.3 NuTiny-SDK-NUC200 PCB Placement

The following figure shows the NuTiny-SDK-NUC200 PCB placement.

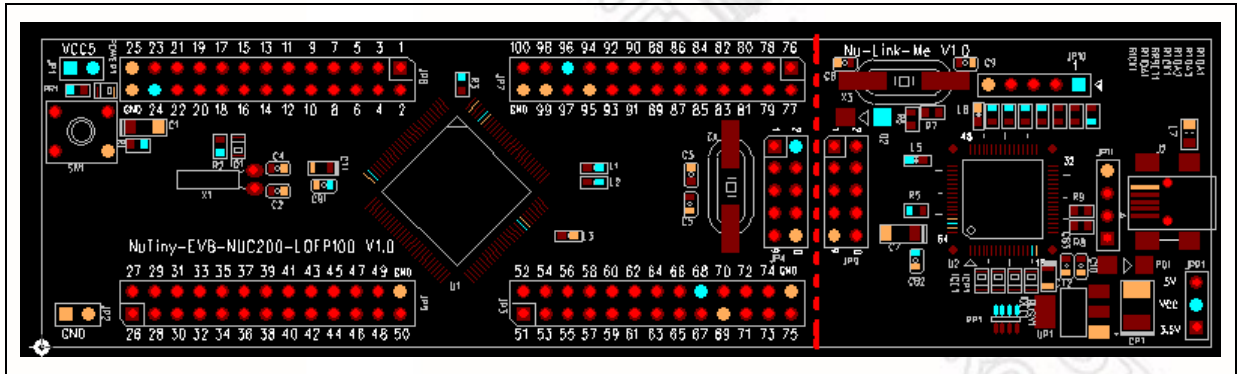

Figure 2-2 NuTiny-SDK-NUC200 PCB Placement

3 Starting to Use NuTiny -SDK-NUC200 on the Keil μ Vision[®] IDE

3.1 Downloading and Installing Keil μ Vision[®] IDE Software

Please connect to the Keil company website (<http://www.keil.com>) to download the Keil μ Vision[®] IDE and install the RVMDK.

3.2 Downloading and Installing Nuvoton Nu-Link Driver

Please connect to Nuvoton NuMicro[™] website (<http://www.nuvoton.com/NuMicro>) to download the “NuMicro[™] Keil μ Vision[®] IDE driver” file. Please refer to section 6.1 for the detailed download flow. After the Nu-Link driver is downloaded, please unzip the file and execute the “Nu-Link_Keil_Driver.exe” to install the driver.

3.3 Hardware Setup

The hardware setup is shown in the following figure.



Figure 3-1 NuTiny-SDK-NUC200 Hardware Setup

3.4 Smpl_NuTiny-NUC200 Program

The example, as shown in the directory of *Figure 3-2*, demonstrates the download and debugging of an application on a NuTiny-SDK-NUC200 board. The example file can be downloaded from Nuvoton NuMicro™ website as described in 6.3 *Downloading NuMicro™ NUC200 series BSP Software Library....*

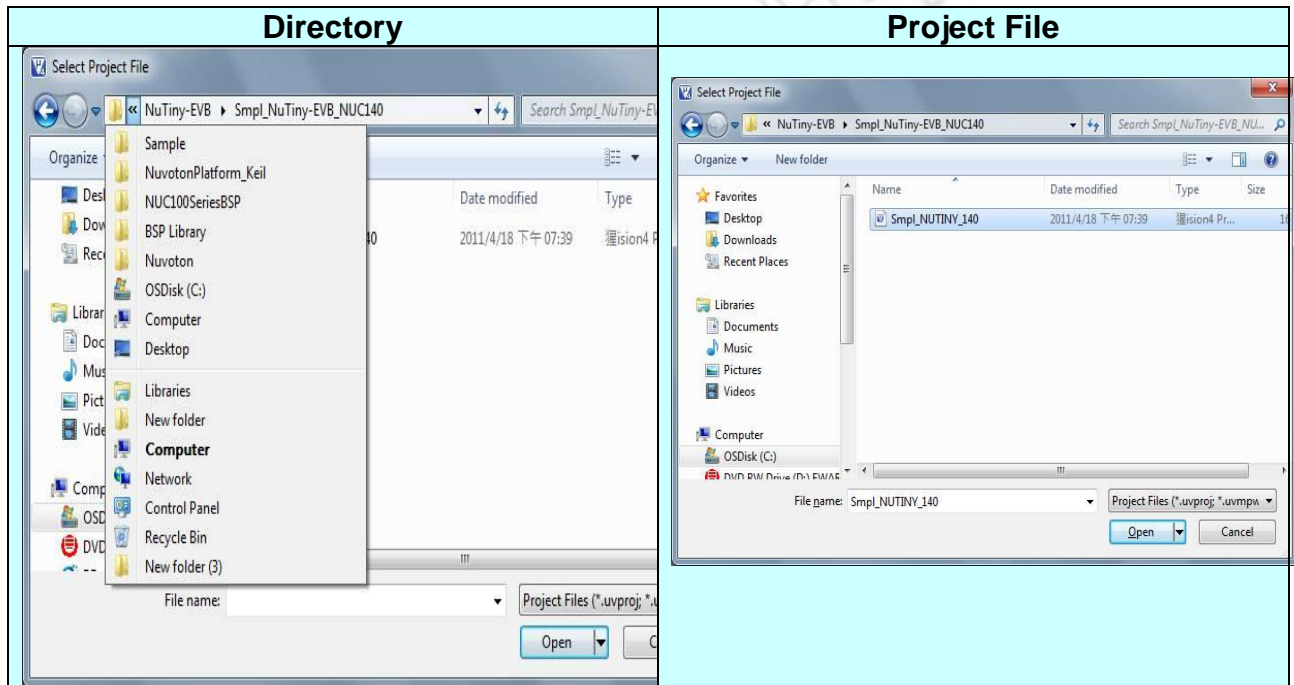









Figure 3-2 Smpl_NuTiny_200 Example Directory

To use this example:

The PA.10 LED will toggle on the NuTiny-EVB-NUC200 board.

-  **Start µVision®**
- **Project-Open**
Open the Smpl_NuTiny_200.uvproj project file
-  **Project - Build**
Compile and link the Smpl_NuTiny_200 application
-  **Flash – Download**
Program the application code into on-chip Flash ROM
-  **Start Debug mode**
When using the debugger commands, you may:
 - ◆  Review variables in the watch window
 - ◆  Single step through code
 - ◆  RST Reset the device
 - ◆  Run the application

4 Starting to Use NuTiny-SDK-NUC200 on the IAR Embedded Workbench

4.1 Downloading and Installing IAR Embedded Workbench Software

Please connect to IAR company website (<http://www.iar.com>) to download the IAR Embedded Workbench and install the EWARM.

4.2 Downloading and Installing Nuvoton Nu-Link Driver

Please connect to Nuvoton Company NuMicro™ website (<http://www.nuvoton.com/NuMicro>) to download the “NuMicro™ IAR ICE Driver User Manual” file. Please refer to section 6.2 for the detailed download flow. When the Nu-Link driver has been well downloaded, please unzip the file and execute the “Nu-Link_IAR_Driver.exe” to install the driver.

4.3 Hardware Setup

The hardware setup is shown in the following figure.

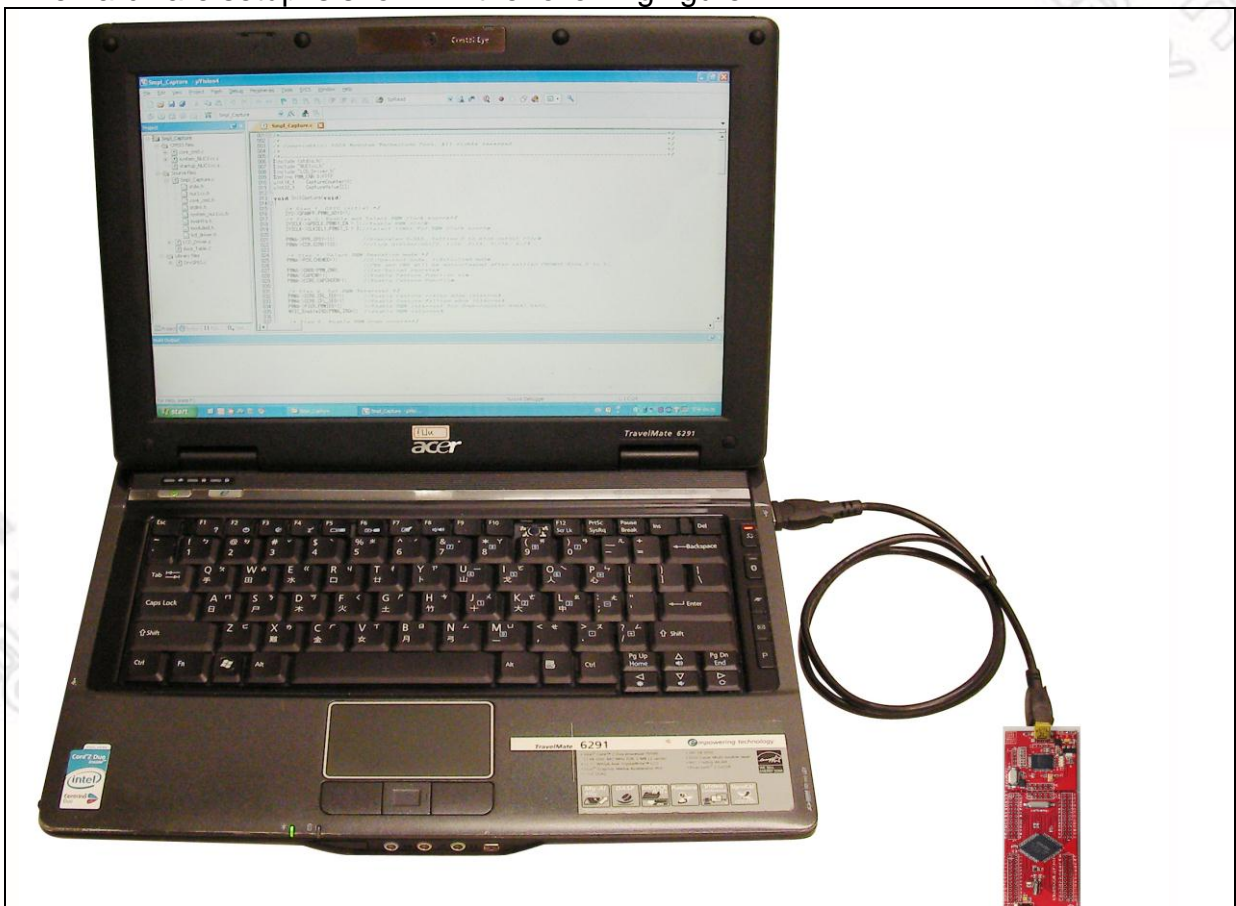

Figure 4-1 NuTiny- SDK-NUC200 Hardware Setup

4.4 Smpl_NuTiny-NUC200 Program

The example, as shown in the directory of *Figure 4-2*, demonstrates the download and debugging of an application on a NuTiny-SDK-NUC200 board. The example file can be downloaded from Nuvoton NuMicro™ website as described in 6.3

Downloading NuMicro™ NUC200 series BSP Software Library....

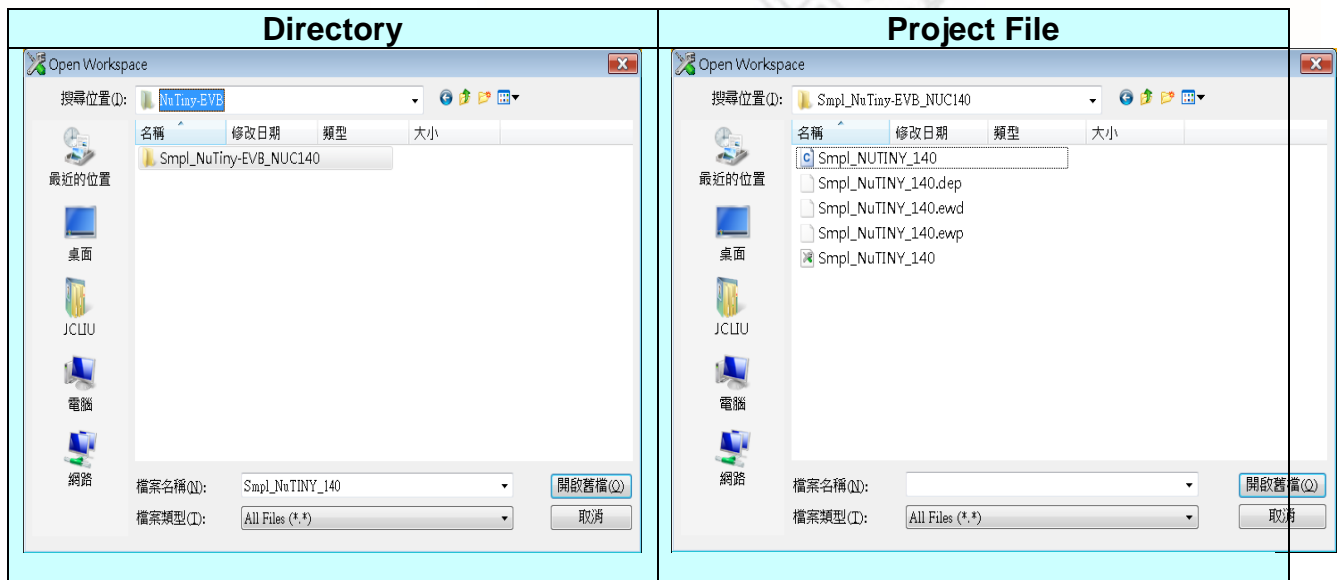

Figure 4-2 Smpl_NuTiny-NUC200 Example Directory

To use this example:

The PA.10 LED will toggle on the NuTiny-EVB-NUC200 board.

- **Start IAR Embedded Workbench**
- **File-Open-Workspace**
Open the NuTiny-EVB-NUC200.eww workspace file
- **Project - Make**
Compile and link the NuTiny-EVB-NUC200 application
- **Project – Download and Debug**
Program the application code into on-chip Flash ROM
 - ◆ Single step through code
 - ◆ Reset the device
 - ◆ Run the application

5 NuTiny-EVB-NUC200 Schematics

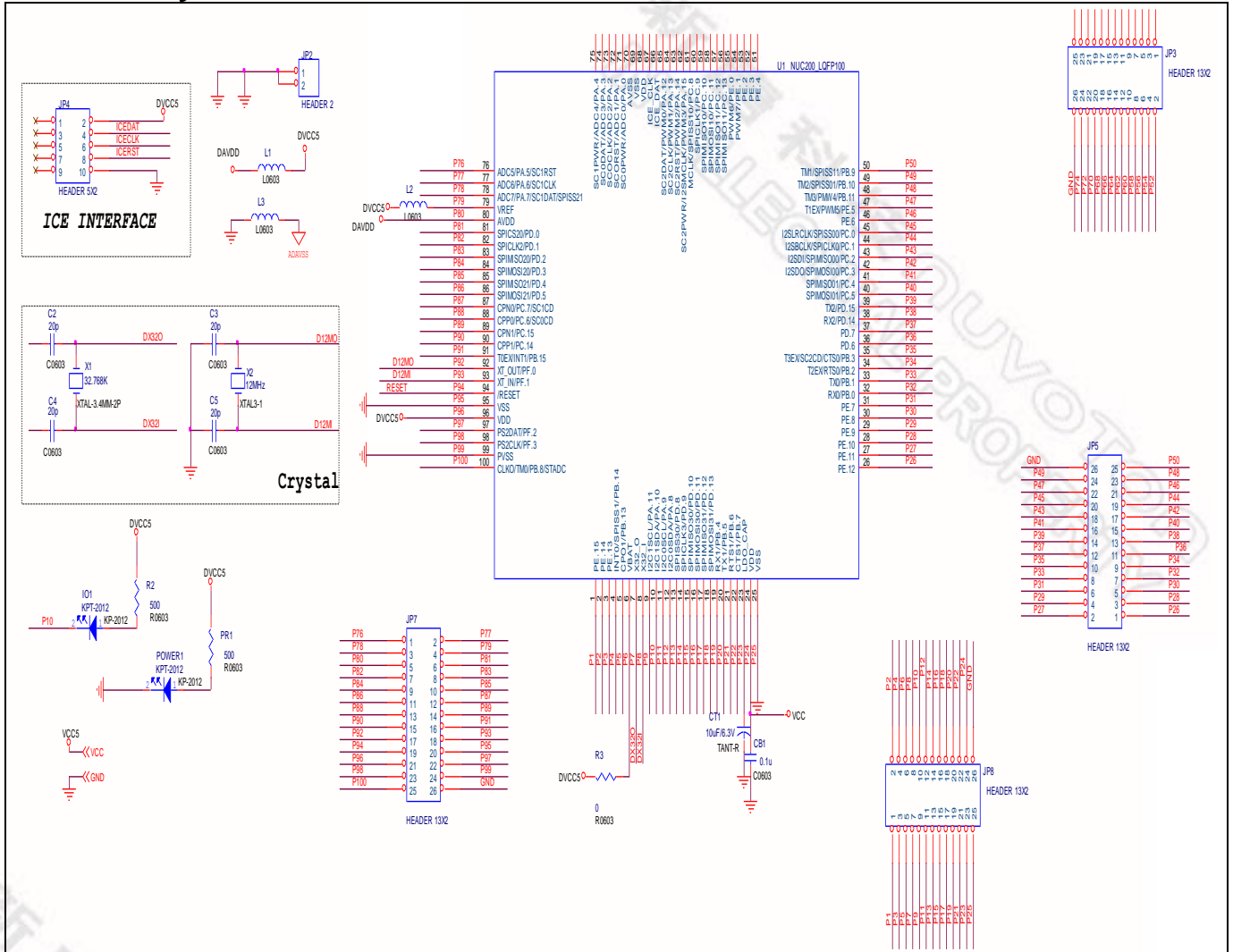

6 Downloading NuMicro™ Related Files from Nuvoton Website

6.1 Downloading NuMicro™ Keil μVision® IDE Driver

<p>Step 1</p>	<p>Visit the Nuvoton NuMicro™ website: http://www.nuvoton.com/NuMicro</p>												
<p>Step 2</p>	<p>The screenshot shows the Nuvoton website for the ARM Cortex™-M0 NuMicro® Family. A red arrow points from a yellow callout box to the 'Device Driver and Software Library' link under the 'Development Resources' section.</p> <p>Click here to enter Device Driver and Software Library</p>												
<p>Step 3</p>	<p>Nu-Link Driver</p> <table border="1"> <thead> <tr> <th>File name</th> <th>Description</th> <th>Version</th> <th>Date</th> </tr> </thead> <tbody> <tr> <td> Nu-Link Driver for Keil RVMDK V1.20.5881.zip Revision History </td> <td>This driver is to support Nu-Link recognized by Keil RVMDK Development Environment and support all NuMicro Family Devices selectable.</td> <td>V1.20.5881</td> <td>12-19-2012</td> </tr> <tr> <td> Nu-Link Driver for IAR EWARM V1.20.5881.zip Revision History </td> <td>This driver is to support Nu-Link recognized by IAR EWARM Development Environment and support all NuMicro Family Devices selectable.</td> <td>V1.20.5881</td> <td>12-19-2012</td> </tr> </tbody> </table>	File name	Description	Version	Date	Nu-Link Driver for Keil RVMDK V1.20.5881.zip Revision History	This driver is to support Nu-Link recognized by Keil RVMDK Development Environment and support all NuMicro Family Devices selectable.	V1.20.5881	12-19-2012	Nu-Link Driver for IAR EWARM V1.20.5881.zip Revision History	This driver is to support Nu-Link recognized by IAR EWARM Development Environment and support all NuMicro Family Devices selectable.	V1.20.5881	12-19-2012
File name	Description	Version	Date										
Nu-Link Driver for Keil RVMDK V1.20.5881.zip Revision History	This driver is to support Nu-Link recognized by Keil RVMDK Development Environment and support all NuMicro Family Devices selectable.	V1.20.5881	12-19-2012										
Nu-Link Driver for IAR EWARM V1.20.5881.zip Revision History	This driver is to support Nu-Link recognized by IAR EWARM Development Environment and support all NuMicro Family Devices selectable.	V1.20.5881	12-19-2012										
<p>Step 4</p>	<p>Download the NuMicro Keil μVision® IDE driver.</p>												

6.2 Downloading NuMicro™ IAR EWARM Driver

<p>Step 1</p>	<p>Visit the Nuvoton NuMicro™ website: http://www.nuvoton.com/NuMicro</p>												
<p>Step 2</p>	<p>The screenshot shows the Nuvoton NuMicro website. The 'Development Resources' section is highlighted with a red dashed box around the 'Device Driver and Software Library' link. A yellow callout bubble with a red arrow points to this link, containing the text: 'Click here to enter Device Driver and Software Library'.</p>												
<p>Step 3</p>	<p>Nu-Link Driver</p> <table border="1"> <thead> <tr> <th>File name</th> <th>Description</th> <th>Version</th> <th>Date</th> </tr> </thead> <tbody> <tr> <td> Nu-Link Driver for Keil RVMDK V1.20.5881.zip Revision History </td> <td>This driver is to support Nu-Link recognized by Keil RVMDK Development Environment and support all NuMicro Family Devices selectable.</td> <td>V1.20.5881</td> <td>12-19-2012</td> </tr> <tr> <td> Nu-Link Driver for IAR EWARM V1.20.5881.zip Revision History </td> <td>This driver is to support Nu-Link recognized by IAR EWARM Development Environment and support all NuMicro Family Devices selectable.</td> <td>V1.20.5881</td> <td>12-19-2012</td> </tr> </tbody> </table>	File name	Description	Version	Date	Nu-Link Driver for Keil RVMDK V1.20.5881.zip Revision History	This driver is to support Nu-Link recognized by Keil RVMDK Development Environment and support all NuMicro Family Devices selectable.	V1.20.5881	12-19-2012	Nu-Link Driver for IAR EWARM V1.20.5881.zip Revision History	This driver is to support Nu-Link recognized by IAR EWARM Development Environment and support all NuMicro Family Devices selectable.	V1.20.5881	12-19-2012
File name	Description	Version	Date										
Nu-Link Driver for Keil RVMDK V1.20.5881.zip Revision History	This driver is to support Nu-Link recognized by Keil RVMDK Development Environment and support all NuMicro Family Devices selectable.	V1.20.5881	12-19-2012										
Nu-Link Driver for IAR EWARM V1.20.5881.zip Revision History	This driver is to support Nu-Link recognized by IAR EWARM Development Environment and support all NuMicro Family Devices selectable.	V1.20.5881	12-19-2012										
<p>Step 4</p>	<p>Download the NuMicro™ IAR Embedded Workbench® driver.</p>												

6.3 Downloading NuMicro™ NUC200 series BSP Software Library

<p>Step 1</p>	<p>Visit the Nuvoton NuMicro™ website: http://www.nuvoton.com/NuMicro</p>
<p>Step 2</p>	<p>The screenshot shows the Nuvoton website's 'ARM Cortex™-M0 NuMicro® Family' page. A red dashed box highlights the 'Device Driver and Software Library' link under the 'Development Resources' section. A yellow callout bubble with a red arrow points to this link, containing the text: 'Click here to enter Device Driver and Software Library.'</p>
<p>Step 3</p>	<p>Download the NuMicro™ NUC200 series software library.</p>

7 Revision History

Revision	Date	Description
1.00	June 24 2014	Initially issued.

Important Notice

Nuvoton Products are neither intended nor warranted for usage in systems or equipment, any malfunction or failure of which may cause loss of human life, bodily injury or severe property damage. Such applications are deemed, "Insecure Usage".

Insecure usage includes, but is not limited to: equipment for surgical implementation, atomic energy control instruments, airplane or spaceship instruments, the control or operation of dynamic, brake or safety systems designed for vehicular use, traffic signal instruments, all types of safety devices, and other applications intended to support or sustain life.

All Insecure Usage shall be made at customer's risk, and in the event that third parties lay claims to Nuvoton as a result of customer's Insecure Usage, customer shall indemnify the damages and liabilities thus incurred by Nuvoton.

Please note that all data and specifications are subject to change without notice.
All the trademarks of products and companies mentioned in this datasheet belong to their respective owners.