

LED DOT MATRIX
BL-M07A571XX
Features:

- Ø 17.80mm (0.7") μ 1.8 dot matrix LED display, BI-COLOR
- Ø Low current operation.
- Ø Excellent character appearance.
- Ø Easy mounting on P.C. Boards or sockets.
- Ø I.C. Compatible.
- Ø ROHS Compliance.

Electrical-optical characteristics: (Ta=25 °C) (Test Condition: IF=20mA)

| Part No | | Chip | | | VF Unit:V | | Iv TYP.(mcd) |
|-----------------------------|-----------------------------|---------------|-----------|------------------|-----------|------|--------------|
| Row Cathode Column Anode | Row Anode Column Cathode | Emitted Color | Material | λ_p (nm) | Typ | Max | |
| BL-M07A571SG-XX | BL-M07B571SG-XX | Super Red | AlGaInP | 660 | 2.10 | 2.50 | 100 |
| | | Green | GaP/GaP | 570 | 2.20 | 2.50 | 95 |
| BL-M07A571EG-XX | BL-M07B571EG-XX | Orange | GaAsP/GaP | 635 | 2.10 | 2.50 | 90 |
| | | Green | GaP/GaP | 570 | 2.20 | 2.50 | 95 |
| BL-M07A571DUG-XX | BL-M07B571DUG-XX | Ultra Red | AlGaInP | 660 | 2.10 | 2.50 | 110 |
| | | Ultra Green | AlGaInP | 574 | 2.20 | 2.50 | 130 |
| BL-M07A571UEUG-X X | BL-M07B571UEUG-X X | Ultra Orange | AlGaInP | 630 | 2.10 | 2.50 | 100 |
| | | Ultra Green | AlGaInP | 574 | 2.20 | 2.50 | 130 |

-XX: Surface / Lens color :

| Number | 0 | 1 | 2 | 3 | 4 | 5 |
|-------------------|-------------|----------------|--------------|----------------|-----------------|---|
| Ref Surface Color | White | Black | Gray | Red | Green | |
| Epoxy Color | Water clear | White diffused | Red Diffused | Green Diffused | Yellow Diffused | |

Absolute maximum ratings (Ta=25°C)

| Parameter | S | G | E | D | UG | UE | | Unit |
|--|--|-----|-----|-----|-----|-----|--|------|
| Forward Current I_F | 30 | 30 | 30 | 30 | 30 | 30 | | mA |
| Power Dissipation P_d | 75 | 80 | 80 | 75 | 75 | 65 | | mW |
| Reverse Voltage V_R | 5 | 5 | 5 | 5 | 5 | 5 | | V |
| Peak Forward Current I_{PF} (Duty 1/10 @1KHZ) | 150 | 150 | 150 | 150 | 150 | 150 | | mA |
| Operation Temperature T_{OPR} | -40 to +80 | | | | | | | °C |
| Storage Temperature T_{STG} | -40 to +85 | | | | | | | °C |
| Lead Soldering Temperature T_{SOL} | Max.260±5 Cfor 3 sec Max. (1.6mm from the base of the epoxy bulb) | | | | | | | °C |

LED DOT MATRIX

BL-M07A571XX

Package configuration & Internal circuit diagram

BL-M07X571 Series

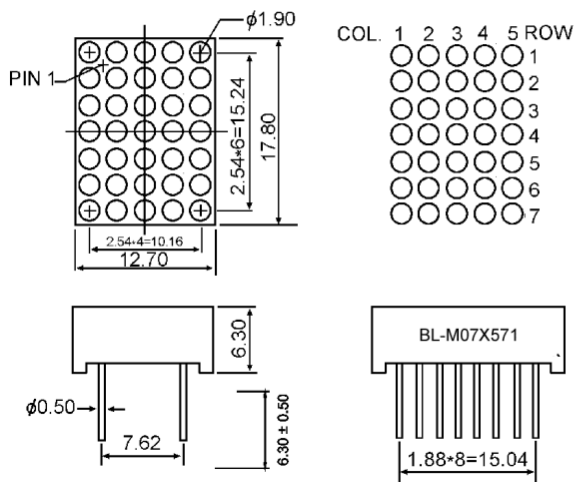

BL-M07A571XX

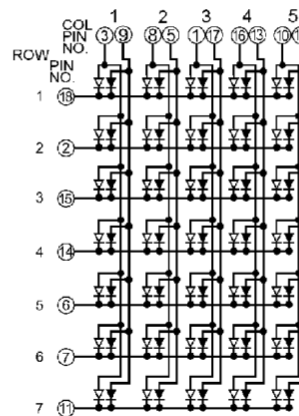

BL-M07B571XX

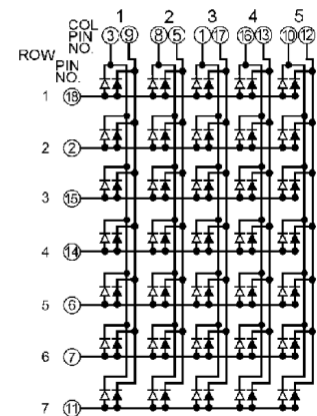

Notes:

1. All dimensions are in millimeters (inches)
2. Tolerance is ± 0.25 (0.01") unless otherwise noted.
3. Specifications are subject to change without notice.

LED DOT MATRIX

BL-M07A571XX

Typical electrical-optical characteristics curves:

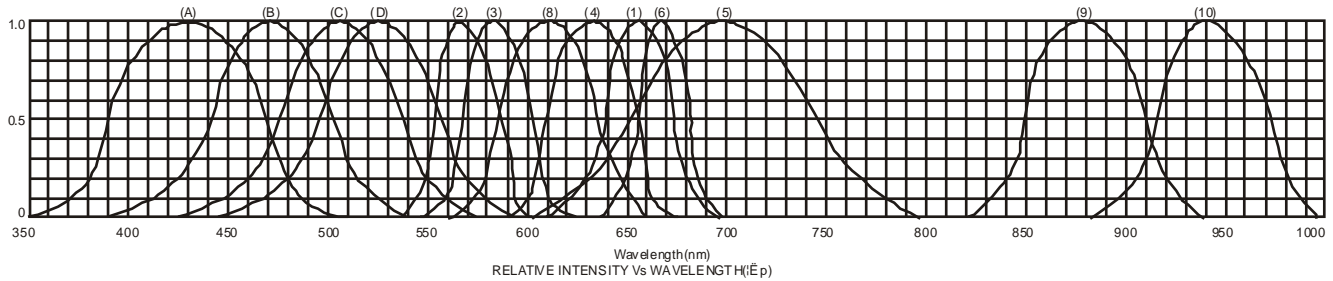

- (1) - GaAsP/GaAs 655nm/Red
- (2) - GaP 570nm/Yellow Green
- (3) - GaAsP/GaP 585nm/Yellow
- (4) - GaAsP/GaP 635nm/Orange & Hi-Eff Red
- (5) - GaP 700nm/Bright Red
- (6) - GaAlAs/GaAs 660nm/Super Red
- (8) - GaAsP/GaP 610nm/Super Red
- (9) - GaAlAs 880nm
- (10) - GaAs/GaAs & GaAlAs/GaAs 940nm
- (A) - GaN/SiC 430nm/Blue
- (B) - InGaN/SiC 470nm/Blue
- (C) - InGaN/SiC 505nm/Ultra Green
- (D) - InGaAlSiC 525nm/Ultra Green

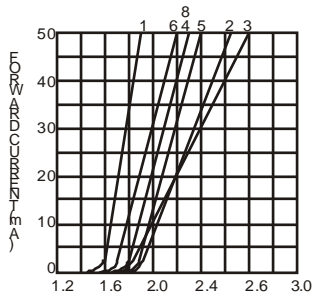

FORWARD VOLTAGE (Vf)
FORWARD CURRENT VS.
FORWARD VOLTAGE

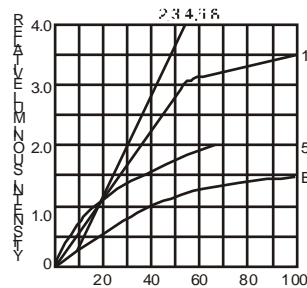

FORWARD CURRENT (mA)
RELATIVE LUMINOUS
INTENSITY VS. FORWARD
CURRENT

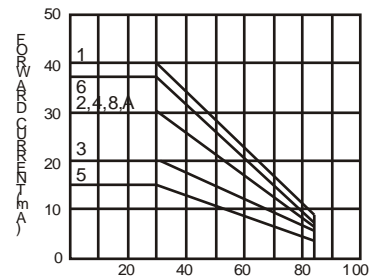

AMBIENT TEMPERATURE Ta ()
FORWARD CURRENT VS. AMBIENT
TEMPERATURE



AMBIENT TEMPERATURE Ta ()

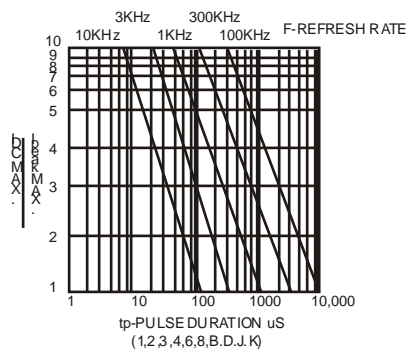

tp-PULSE DURATION μ s
(1,2,3,4,6,8,B,D,J,K)

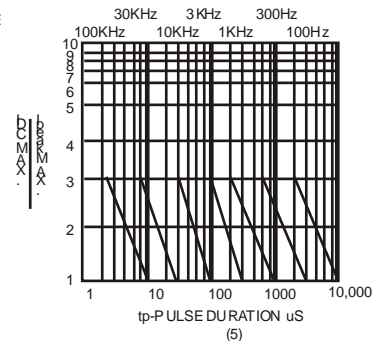

tp-PULSE DURATION μ s
(5)

NOTE:25 free air temperature unless otherwise specified