

Cortex™-M0

32-bit Microcontroller

1 GENERAL DESCRIPTION

The NUC120 series are 32-bit microcontrollers with embedded ARM® Cortex™-M0 core for industrial control and applications **need USB communication**. The Cortex™-M0 is the newest ARM embedded processor with 32-bit performance and at a cost equivalent traditional 8-bit microcontroller.

The NUC120 series embeds Cortex™-M0 core running up to 50MHz with 32K/64K/128K-byte embedded flash and 4K/8K/16K-byte embedded SRAM. It also equips with plenty of peripheral devices, such as Timers, Watchdog Timer, RTC, PDMA, UART, SPI/SSP, I²C, I²S, PWM Timer, GPIO, USB 2.0 FS Device, 12-bit ADC, Analog Comparator, Low Voltage Detector and Brown-out detector.

2 FEATURES

- Core
 - ARM® Cortex™-M0 core runs up to 50MHz.
 - One 24-bit system timer.
 - Low power sleep mode supports.
 - Single-cycle 32-bit hardware multiplier.
 - NVIC for the 32 interrupt inputs, each with 4-levels of priority.
 - Serial Wire Debug supports with 2 watchpoints/4 breakpoints.
- Widely operating voltage range from 2.5V to 5.5V
- Flash EPROM Memory
 - 32K/64K/128K bytes Flash EPROM for program code.
 - 4kB flash for ISP loader
 - Support ISP/IAP program code update
 - 512 byte page erase for flash
 - Configurable data flash address and size for 128kB system, fixed 4kB data flash for the 32kB and 64kB system.
 - Support 2 wire ICP update from ICE interface
 - Support fast parallel programming mode by external programmer.
- SRAM Memory
 - 4K/8K/16k bytes embedded SRAM.
 - Support PDMA mode





- PDMA (Peripheral DMA)
 - Support 9 channels PDMA for automatic data transfer between SRAM and peripherals.
- Clock Control
 - Flexible selection for different applications.
 - Build-in 22MHz OSC (Trimmed to 1%) for system operation, and low power 10KHz OSC for watchdog and wakeup sleep operation.
 - Support one PLL, up to 50MHz, for high performance system operation.
 - External 12MHz crystal input for USB and precise timing operating mode.
 - External 32 kHz crystal input for RTC function and low power system operation.
- GPIO
 - Four I/O modes:
 - ◆ Quasi bi-direction
 - ◆ Push-Pull output
 - ◆ Open-Drain output
 - ◆ Input only with high impedance
 - TTL/Schmitt trigger input selectable.
 - I/O pin can be configured as interrupt source with edge/level setting.
 - High driver and high sink IO mode support.
- Timers
 - 4 sets of 24-bit timer with 8-bit pre-scaler.
 - Counter auto reload.
- Watch Dog Timer
 - Default ON/OFF by configuration setting
 - Multiple clock sources
 - 8 selectable time out period from 6ms ~ 3.0sec (depends on clock source)
 - WDT can wake up power down/sleep.
 - Interrupt or reset selectable on watchdog time-out.
- RTC
 - Support software compensation by setting frequency compensate register (FCR)
 - Support RTC counter (second, minute, hour) and calendar counter (day, month, year)
 - Support Alarm registers (second, minute, hour, day, month, year)
 - Switchable 12-hour or 24-hour mode
 - Automatic leap year recognition
 - Support time tick interrupt
 - Support wake up function.
- PWM/Capture
 - Built-in up to four 16-bit PWM generators provide eight PWM outputs or four complementary paired PWM outputs.
 - Each PWM generator equipped with one clock source selector, one clock divider, one 8-bit pre-scaler and one Dead-Zone generator for complementary paired PWM.
 - PWM interrupt synchronous to PWM period.
 - Up to eight 16-bit digital Capture timers(shared with PWM timers) provide eight rising/falling capture inputs.
 - Support Capture interrupt



- UART
 - Up to three compatible 16550 UART devices.
 - UART ports with flow control (TX, RX, CTS and RTS)
 - UART0 with 64-byte FIFO is for high speed
 - UART1/2(optional) with 16-byte FIFO for standard device
 - Support IrDA(SIR) function
 - Programmable baud-rate generator up to 1/16 system clock
 - Support PDMA mode
- SPI
 - Up to four sets of SPI device.
 - Master up to 16 Mbps / Slave up to 10 Mbps.
 - Support MICROWIRE/SPI master/slave mode (SSP)
 - Full duplex synchronous serial data transfer
 - Variable length of transfer data from 1 to 32 bits
 - MSB or LSB first data transfer
 - Rx and Tx on both rising or falling edge of serial clock independently
 - 2 slave/device select lines when it is as the master, and 1 slave/device select line when it is as the slave
 - Byte Sleeping mode in 32-bit transmission
 - Support PDMA mode
- I²C
 - Two sets of I²C device.
 - Master/Slave up to 1Mbit/s (Fast-mode Plus)
 - Bidirectional data transfer between masters and slaves
 - Multi-master bus (no central master).
 - Arbitration between simultaneously transmitting masters without corruption of serial data on the bus
 - Serial clock synchronization allows devices with different bit rates to communicate via one serial bus.
 - Serial clock synchronization can be used as a handshake mechanism to suspend and resume serial transfer.
 - Programmable clocks allow versatile rate control.
 - I2C-bus controllers support multiple address recognition (two slave address with mask option)
- I²S
 - Interface with external audio CODEC
 - Operate as either master or slave mode
 - Capable of handling 8, 16, and 32 bit word sizes
 - Mono and stereo audio data supported
 - I2S and MSB justified data format supported
 - Two 8 word FIFO data buffers are provided, one for transmit and one for receive
 - Generates interrupt requests when buffer levels cross a programmable boundary
 - Support two DMA requests, one for transmit and one for receive



- USB 2.0 Full-Speed Device
 - One set of USB 2.0 FS Device 12Mbps
 - On-chip USB Transceiver.
 - Provide 1 interrupt source with 4 interrupt events.
 - Support Control, Bulk In/Out, Interrupt and Isochronous transfers.
 - Auto suspend function when no bus signaling for 3 ms.
 - Provide 6 programmable endpoints.
 - Include 512 Bytes internal SRAM as USB buffer.
 - Provide remote wakeup capability.
 - Support PDMA mode
- ADC
 - 12-bit SAR ADC with 800ksps
 - Up to 8-ch single-end mode or 4-ch differential-end mode
 - Single scan/single cycle scan/continuous scan
 - Each channel with individual result register
 - Scan on enabled channels
 - Threshold voltage detection
 - Conversion start by S/W, external pins
- Analog Comparator
 - 2 comparator analog modules
 - External input or internal bandgap voltage selectable at negative node
 - Interrupt when compare result change
 - Power down wake up
- Temperature sensor
 - One temperature sensor built-in with 1°C resolution.
- Brown-out detector
 - with 4 levels: 4.5V/3.8V/2.7V/2.4V
 - Support Brownout Interrupt and Reset option
- LDO
 - One LDO is built-in.
- Low Voltage Reset
- Operating Temperature: -40°C ~85°C
- Packages:
 - All Green package (RoHS)
 - ◆ LQFP 100-pin / 64-pin / 48-pin



3 PIN DIAGRAM

- LQFP 100 pin

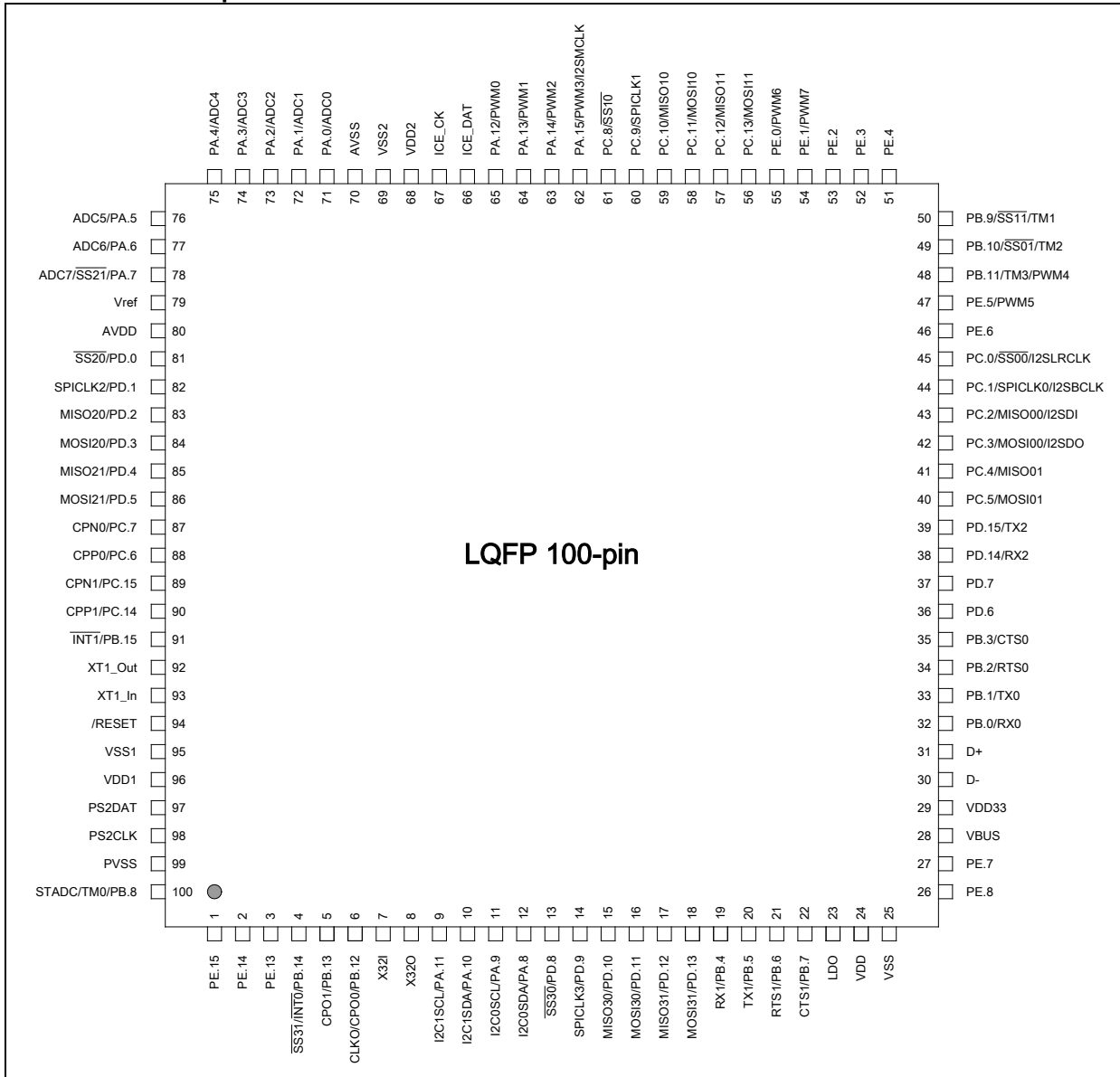



- LQFP 64 pin

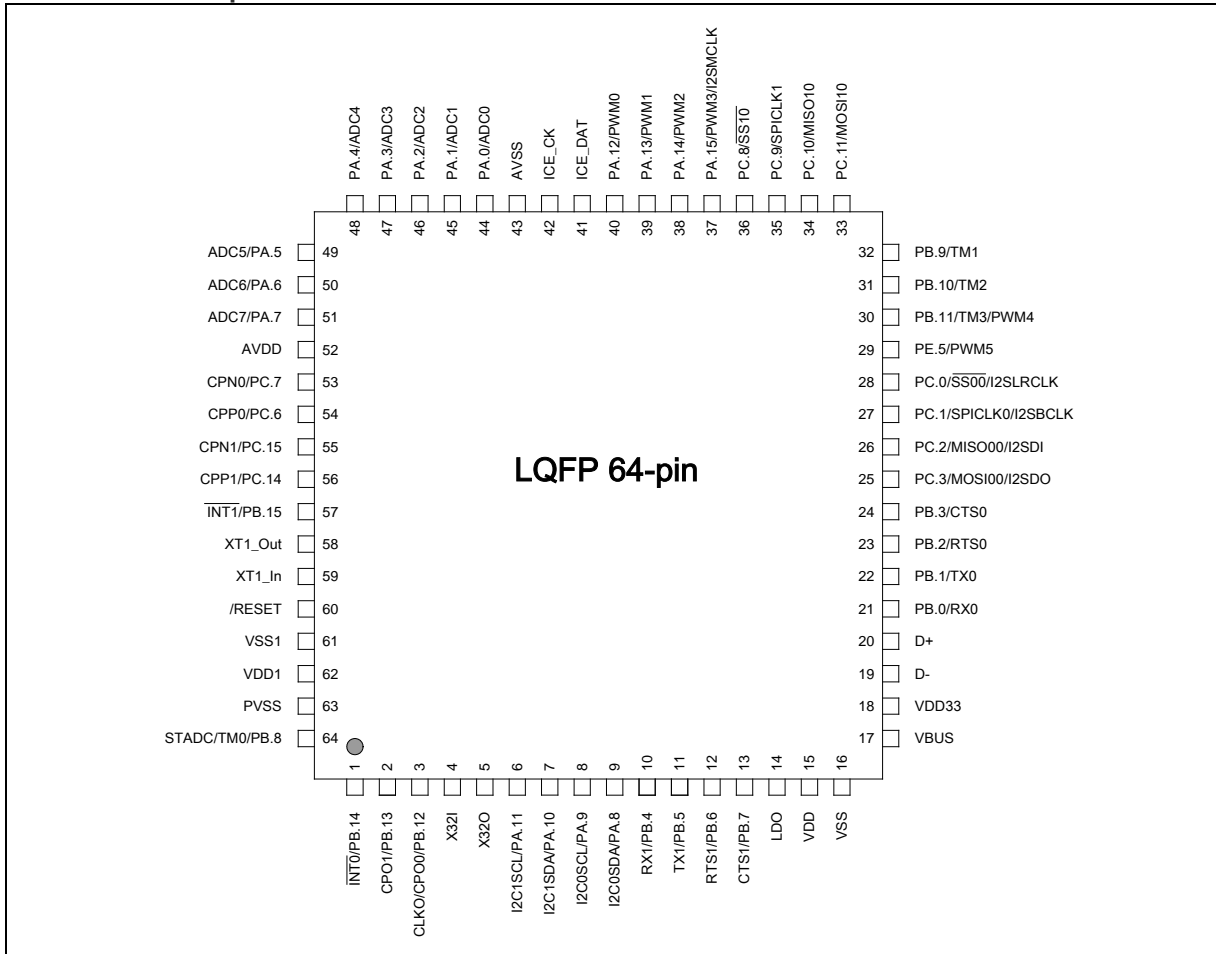



- LQFP 48 pin

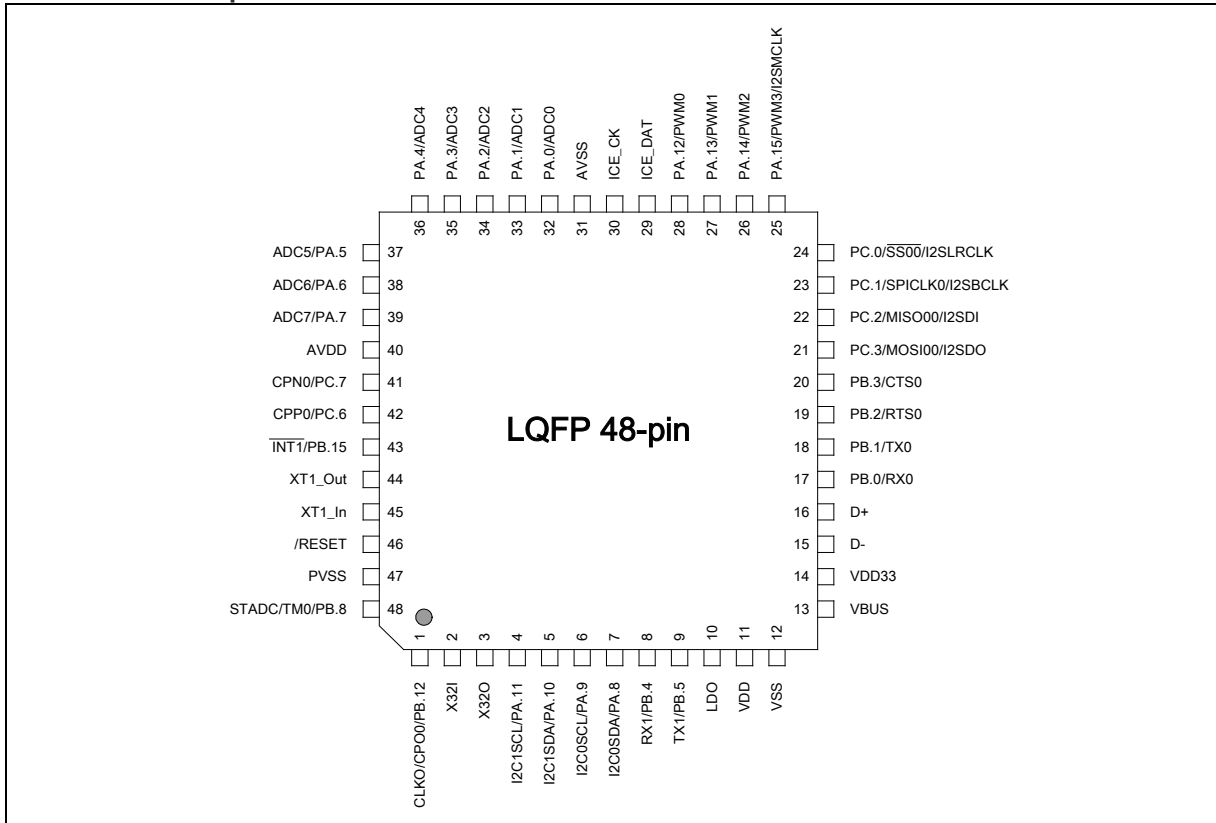

4 PACKAGE DIMENSIONS

4.1 100L LQFP (14x14x1.4mm footprint 2.0mm)

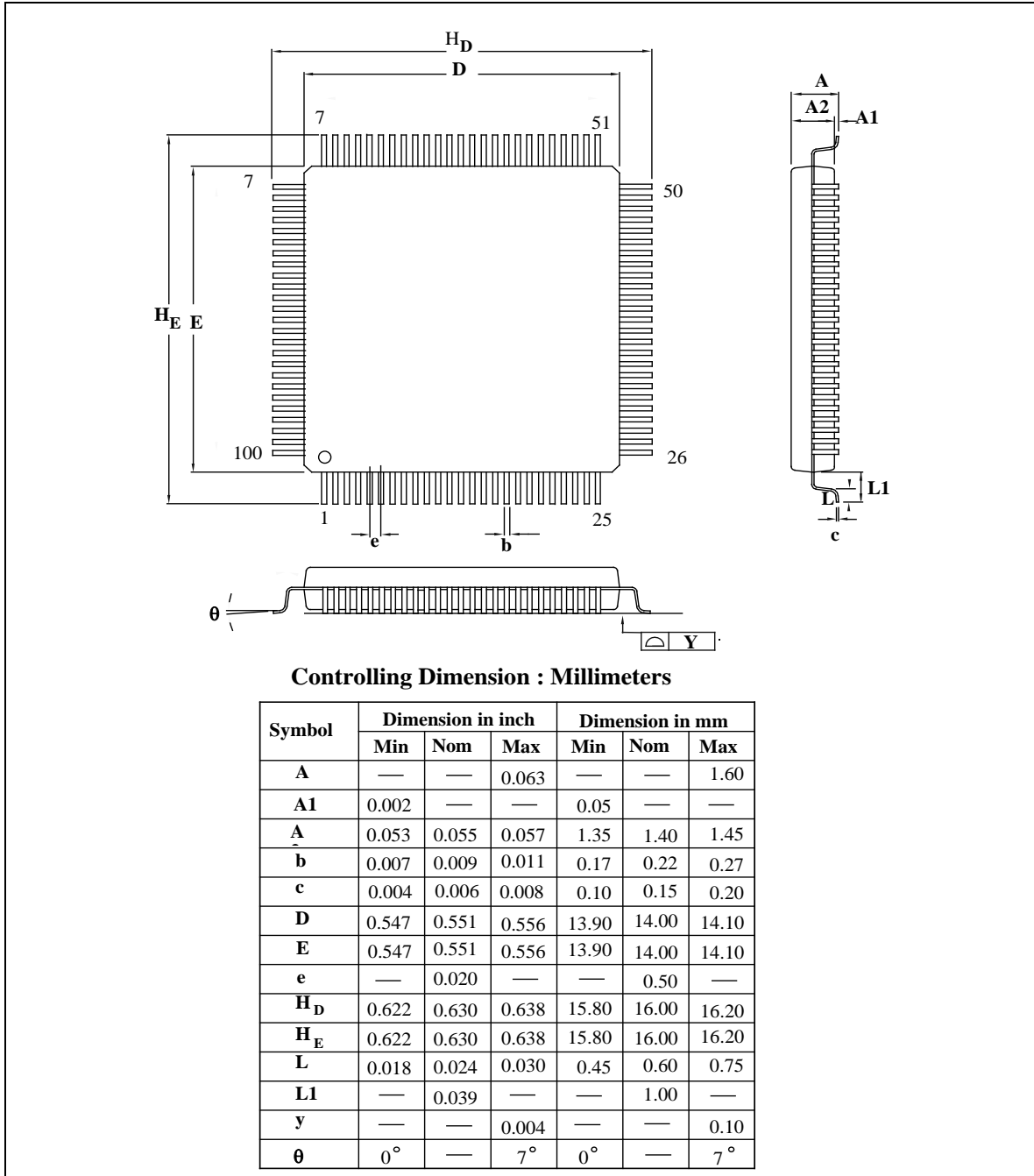

4.2 64L LQFP (10x10x1.4mm footprint 2.0mm)

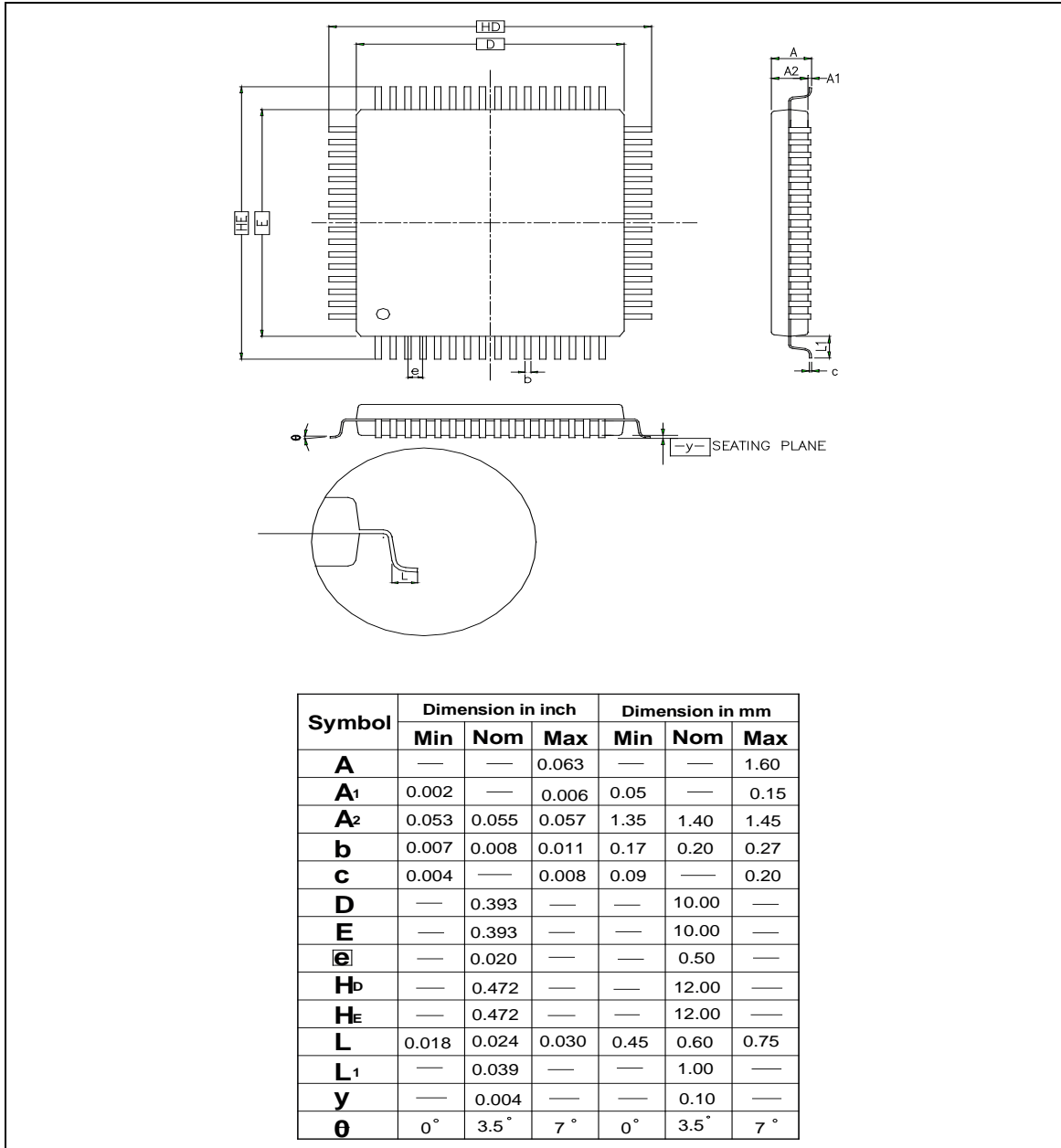

4.3 48L LQFP (7x7x1.4mm footprint 2.0mm)

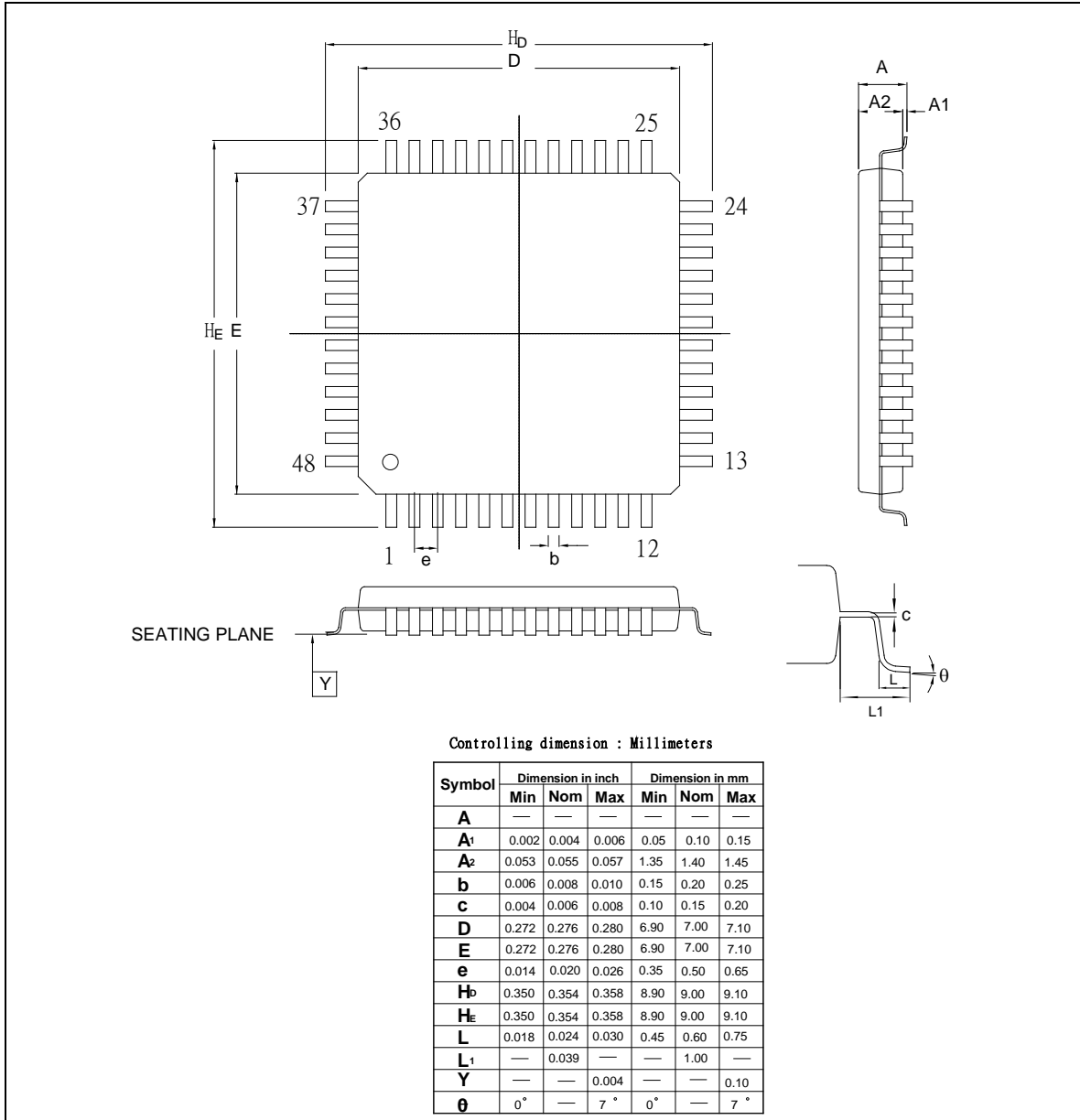



5 ELECTRICAL CHARACTERISTICS

5.1 DC Characteristics

(V_{DD}-V_{SS}=3.3V, T_A = 25°C, F_{OSC} = 50Mhz unless otherwise specified.)

PARAMETER	SYM.	SPECIFICATION				TEST CONDITIONS
		MIN.	TYP.	MAX.	UNIT	
Operation voltage	V _{DD}	2.5		5.5	V	V _{DD} =2.5V ~ 5.5V up to 50MHz
Power Ground	V _{SS} AV _{SS}	-0.3			V	
LDO Output Voltage (bypass = 0)	V _{LDO}	-10%	2.45	+10%	V	
LDO Output Voltage (bypass = 0)	V _{LDO}	-10%	V _{DD}	+10%	V	V _{DD} < 2.7V
Analog Operating Voltage	AV _{DD}	0		V _{DD}	V	
Analog Reference Voltage	V _{ref}	0		AV _{DD}	V	
Operating Current	I _{DD1}		42		mA	Normal run, all peripherals on
	I _{DD2}		26		mA	Normal run, all peripherals off
	I _{DD3}		10		uA	Deep sleep mode, all peripherals off
Input Current PA~PE	I _{IN1}	-60	-	+15	μA	V _{DD} = 5.5V, V _{IN} = 0V or V _{IN} =V _{DD}
Input Current at /RESET ^[1]	I _{IN2}	-55	-45	-30	μA	V _{DD} = 5.5V, V _{IN} = 0.45V
Input Leakage Current PA~PE	I _{LK}	-2	-	+2	μA	V _{DD} = 5.5V, 0<V _{IN} <V _{DD}
Logic 1 to 0 Transition Current PA~PE (Quasi-bidiretional mode)	I _{TL} ^[*3]	-650	-	-200	μA	V _{DD} = 5.5V, V _{IN} <2.0V
Input Low Voltage P0, P1, P2, P3, P4 (TTL input)	V _{IL1}	-0.3	-	1.0	V	V _{DD} = 4.5V
		-0.3	-	0.6		V _{DD} = 2.5V
Input High Voltage P0, P1, P2, P3, P4 (TTL input)	V _{IH1}	2.2	-	V _{DD} +0.2	V	V _{DD} = 5.5V
		1.5	-	V _{DD} +0.2		V _{DD} =3.0V
Input Low Voltage XT1 ^[*2]	V _{IL3}	0	-	0.8	V	V _{DD} = 4.5V
		0	-	0.4		V _{DD} = 3.0V
Input High Voltage XT1 ^[*2]	V _{IH3}	3.5	-	V _{DD} +0.2	V	V _{DD} = 5.5V
		2.4	-	V _{DD} +0.2		V _{DD} = 3.0V

Input Low Voltage X32I ^[2]	V _{IL4}	0	-	0.8		
		0	-	0.4		
Input High Voltage X32O ^[2]	V _{IH4}	3.5	-	V _{DD} +0.2		
		2.4	-	V _{DD} +0.2		
Negative going threshold (Schmitt input), /RST	V _{ILS}	-0.5	-	0.3V _{DD}	V	
Positive going threshold (Schmitt input), /RST	V _{IHS}	0.7V _{DD}	-	V _{DD} +0.5	V	
Internal /RST pin pull up resistor	R _{RST}	50		100	KΩ	
Hysteresis voltage	V _{HY}				V	
Source Current PA~PE (Quasi-bidirectional Mode)	I _{SR11}	-300	-370	-450	μA	V _{DD} = 4.5V, V _S = 2.4V
	I _{SR12}	-50	-70	-90	μA	V _{DD} = 2.7V, V _S = 2.2V
	I _{SR12}	-40	-60	-80	μA	V _{DD} = 2.5V, V _S = 2.0V
Source Current PA~PE (Push-pull Mode)	I _{SR21}	-20	-24	-28	mA	V _{DD} = 4.5V, V _S = 3.0V
	I _{SR22}	-4	-6	-8	mA	V _{DD} = 2.7V, V _S = 2.2V
	I _{SR22}	-3	-5	-7	mA	V _{DD} = 2.5V, V _S = 2.0V
Sink Current PA~PE (Quasi-bidirectional and Push-pull Mode)	I _{SK1}	10	16	20	mA	V _{DD} = 4.5V, V _S = 0.45V
	I _{SK1}	7	10	13	mA	V _{DD} = 2.7V, V _S = 0.45V
	I _{SK1}	6	9	12	mA	V _{DD} = 2.5V, V _S = 0.45V
Brownout voltage with BOV_VL [1:0] =00b	V _{BO2.2}	2.1	2.2	2.3	V	
Brownout voltage with BOV_VL [1:0] =01b	V _{BO2.7}	2.6	2.7	2.8	V	
Brownout voltage with BOV_VL [1:0] =10b	V _{BO3.8}	3.7	3.8	3.9	V	
Brownout voltage with BOV_VL [1:0] =11b	V _{BO4.5}	4.4	4.5	4.6	V	
Hysteresis range of BOD voltage	V _{Bh}	30	-	150	mV	V _{DD} = 2.4V~5.5V

Notes:

1. /RST pin is a Schmitt trigger input.
2. XTAL1 is a CMOS input.
3. Pins of P0, P1, P2, P3 and P4 can source a transition current when they are being externally driven from 1 to 0. The transition current reaches its maximum value when V_{in} approximates to 2V.

5.2 AC Characteristics

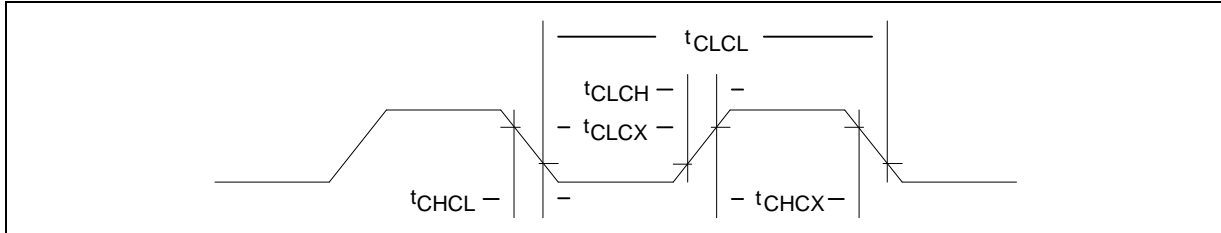

Note: Duty cycle is 50%.

PARAMETER	SYMBOL	MIN.	TYP.	MAX.	UNITS	CONDITION
Clock High Time	t_{CHCX}	20	-	-	nS	
Clock Low Time	t_{CLCX}	20	-	-	nS	
Clock Rise Time	t_{CLCH}	-	-	10	nS	
Clock Fall Time	t_{CHCL}	-	-	10	nS	

5.2.1 External XTAL1 Oscillator

PARAMETER	CONDITION	MIN.	TYP.	MAX.	UNIT
Input clock frequency	External crystal	4	12	24	MHz
Temperature	-	-40	-	85	°C
V_{DD}	-	2.5	5	5.5	V
Operating current	12MHz@ $V_{DD} = 5V$	-	5	-	mA

5.2.1.1 Typical Crystal Application Circuits

CRYSTAL	C1	C2	R
4MHz ~ 24 MHz	without	without	without

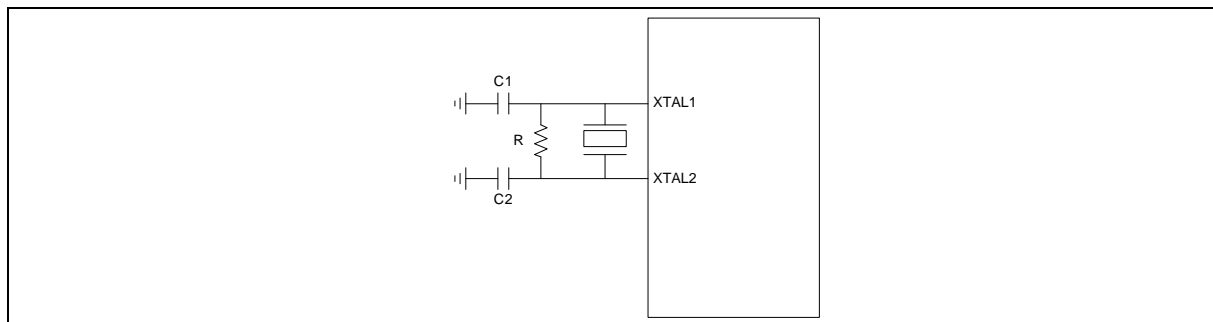

Figure 7-1 Typical Crystal Application Circuit



5.2.2 External 32KHz XTAL Oscillator

PARAMETER	CONDITION	MIN.	TYP.	MAX.	UNIT
Input clock frequency	External crystal	-	32	-	KHz
Temperature	-	-40	-	85	°C
V _{DD}	-	2.5	-	5.5	V
Operating current	V _{DD} = 5V	-	5	-	uA

5.2.3 Internal 22.1184MHz RC Oscillator

PARAMETER	CONDITION	MIN.	TYP.	MAX.	UNIT
Supply voltage ^[1]	-	2.5	-	5.5	V
Center Frequency	-	-	22.1184	-	MHz
Calibrated Internal Oscillator Frequency	+25°C; V _{DD} =5V	-1	-	+1	%
	-40°C~+85°C; V _{DD} =2.5V~5.5V	-3	-	+3	%
Accuracy of Un-calibrated Internal Oscillator Frequency	-40°C~+85°C; V _{DD} =2.5V~5.5V	-25	-	+25	%
Operating current	V _{DD} =5V	-	500	-	uA

5.2.4 Internal 10KHz RC Oscillator

PARAMETER	CONDITION	MIN.	TYP.	MAX.	UNIT
Supply voltage ^[1]	-	2.5	-	5.5	V
Center Frequency	-	-	10	-	KHz
Calibrated Internal Oscillator Frequency	+25°C; V _{DD} =5V	-30	-	+30	%
	-40°C~+85°C; V _{DD} =2.5V~5.5V	-50	-	+50	%
Operating current	V _{DD} =5V	-	5	-	uA

Notes:

1. Internal operation voltage comes from LDO.



5.3 Analog Characteristics

5.3.1 Specification of 1-MS/s 12-bit SARADC

PARAMETER	SYM.	MIN.	TYP.	MAX.	UNIT
Resolution	-	-	-	12	Bit
Differential nonlinearity error	DNL	-	±3	-	LSB
Integral nonlinearity error	INL	-	±4	-	LSB
Offset error	EO	-	±1	10	LSB
Gain error (Transfer gain)	EG	-	1	1.005	-
Monotonic	-	Guaranteed			-
ADC clock frequency	FADC	-	-	20	MHz
Calibration time	TCAL	-	127	-	Clock
Sample time	TS	-	7	-	Clock
Conversion time	TADC	-	13	-	Clock
Sample rate	FS	-	-	800	Ksps
Supply voltage	V _{LDO}	-	2.5	-	V
	V _{ADD}	3	-	5.5	V
Supply current (Avg.)	I _{DD}	-	0.5	-	mA
	I _{DDA}	-	1.5	-	mA
Reference voltage	V _{REFP}	-	V _{DDA}	-	V
Reference current (Avg.)	I _{REFP}	-	1	-	mA
Input voltage range	V _{IN}	0	-	V _{REFP}	V
Capacitance	C _{IN}	-	5	-	pF

5.3.2 Specification of LDO & Power management

PARAMETER	MIN	TYP	MAX	UNIT	NOTE
Input Voltage	2.7	5	5.5	V	V _{DD} input voltage
Output Voltage (bypass=0)	-10%	2.45	+10%	V	LDO output voltage
Output Voltage (bypass=1)	-10%	Input Voltage	+10%	V	Input Voltage < 2.7V
Temperature	-40	25	85	oC	
Quiescent Current (PD=0, bypass=0)	-	100	-	uA	
Quiescent Current (PD=1, bypass=0)	-	5	-	uA	
Quiescent Current (PD=1, bypass=1)	-	5	-	uA	
Iload (PD=0)	-	-	100	mA	
Iload (PD=1)	-	-	100	uA	
Cbp	-	1u	-	F	Resr=1ohm
Cload	-	250p	-	F	

Note:

1. It is recommended that a 10uF or higher capacitor and a 100nF bypass capacitor are connected between VDD and the closest VSS pin of the device.
2. For ensuring power stability, a 4.7uF or higher capacitor must be connected between LDO pin and the closest VSS pin of the device. Also a 100nF bypass capacitor between LDO and VSS help suppressing output noise.



5.3.3 Specification of Low Voltage Reset

PARAMETER	CONDITION	MIN.	TYP.	MAX.	UNIT
Operation voltage	-	1.7	-	5.5	V
Quiescent current	VDD5V=5.5V	-	-	5	uA
Temperature	-	-40	25	85	°C
Threshold voltage	Temperature=25°	1.7	2.0	2.3	V
	Temperature=-40°	-	2.4	-	V
	Temperature=85°	-	1.6	-	V
Hysteresis	-	0	0	0	V

5.3.4 Specification of Brownout Detector

Parameter	Condition	Min.	Typ.	Max.	Unit
Operation voltage	-	2.5	-	5.5	V
Quiescent current	AVDD=5.5V	-	-	125	μA
Temperature	-	-40	25	85	°C
Brown-out voltage	BOV_VL[1:0]=11	4.4	4.5	4.6	V
	BOV_VL [1:0]=10	3.7	3.8	3.9	V
	BOV_VL [1:0]=01	2.6	2.7	2.8	V
	BOV_VL [1:0]=00	2.1	2.2	2.3	V
Hysteresis	-	30m	-	150m	V

5.3.5 Specification of Power-On Reset (5V)

Parameter	Condition	Min.	Typ.	Max.	Unit
Temperature	-	-40	25	85	°C
Reset voltage	V+	-	2	-	V
Quiescent current	Vin>reset voltage	-	1	-	nA



5.3.6 Specification of Temperature Sensor

PARAMETER	MIN	TYP	MAX	UNIT	Conditions
Supply voltage ^[1]	2.5	-	5.5	V	
Temperature	-40	-	125	°C	
Current consumption	6.4	-	10.5	uA	
Gain	-1.95	-2	-2.05	mV/°C	
Offset	688	708	730	mV	Temp=0 °C

Notes:

1. Internal operation voltage comes from LDO.

5.3.7 Specification of Comparator

PARAMETER	MIN.	TYP.	MAX.	Condition
Temperature	-40°C	25 °C	85°C	-
VDD	2.4	3	5.5	-
VDD current	-	20uA	40uA	20uA@VDD=3V
Input offset voltage	-	5mV	15mV	-
Output swing	0.1	-	VDD-0.1	-
Input common mode range	0.1	-	VDD-1.2	-
DC gain	-	70dB	-	-
Propagation delay	-	200ns	-	@VCM=1.2V & VDIFF=0.1V
Comparison voltage	10mV	20mV	-	20mV@VCM=1V 50mV@VCM=0.1V 50mV@VCM=VDD-1.2 @10mV for non-hysteresis
Hysteresis	-	±10mV	-	One bit control W/O & W. hysteresis @VCM=0.4V ~ VDD-1.2V
Wake up time	-	-	2us	@CINP=1.3V CINN=1.2V



5.3.8 Specification of USB PHY

5.3.8.1 USB DC Electrical Characteristics

Symbol	Parameter	Conditions	Min.	Typ	Max.	Unit
V _{IH}	Input high (driven)		2.0			V
V _{IL}	Input low				0.8	V
V _{DI}	Differential input sensitivity	PADP-PADM	0.2			V
V _{CM}	Differential common-mode range	Includes V _{DI} range	0.8		2.5	V
V _{SE}	Single-ended receiver threshold		0.8		2.0	V
	Receiver hysteresis			200		mV
V _{OL}	Output low (driven)		0		0.3	V
V _{OH}	Output high (driven)		2.8		3.6	V
V _{CRS}	Output signal cross voltage		1.3		2.0	V
R _{PU}	Pull-up resistor		1.425		1.575	kΩ
R _{PD}	Pull-down resistor		14.25		15.75	kΩ
V _{TRM}	Termination Voltage for upstream port pull up (R _{PU})		3.0		3.6	V
Z _{DRV}	Driver output resistance	Steady state drive*		10		Ω
C _{IN}	Transceiver capacitance	Pin to GND			20	pF

*Driver output resistance doesn't include series resistor resistance.

5.3.8.2 USB Full-Speed Driver Electrical Characteristics

Symbol	Parameter	Conditions	Min.	Typ	Max.	Unit
T _{FR}	Rise Time	C _L =50p	4		20	ns
T _{FF}	Fall Time	C _L =50p	4		20	ns
T _{FRFF}	Rise and fall time matching	T _{FRFF} =T _{FR} /T _{FF}	90		111.11	%

5.3.8.3 USB Power Dissipation

Symbol	Parameter	Conditions	Min.	Typ	Max.	Unit
I _{VDDREG} (Full Speed)	VDDD and VDDREG Supply Current (Steady State)	Standby		50		uA
		Input mode				uA
		Output mode				uA



6 NUC120 PRODUCTS SELECTION GUIDE

NUC120 series USB Line Selection Guide (Medium Density)

Part number	Flash	SRAM	Connectivity				I ² S	PWM	Comp.	ADC	Timer	RTC	ISP ICP	I/O	Package
			UART	SPI/SSI	I ² C	USB									
NUC120LE3AN	128 KB	16 KB	2	1	2	1	1	4	1	8x12-bit	4x24-bit	v	v	up to 31	LQFP48
NUC120LD3AN	64 KB	16 KB	2	1	2	1	1	4	1	8x12-bit	4x24-bit	v	v	up to 31	LQFP48
NUC120RE3AN	128 KB	16 KB	2	2	2	1	1	6	2	8x12-bit	4x24-bit	v	v	up to 45	LQFP64
NUC120RD3AN	64 KB	16 KB	2	2	2	1	1	6	2	8x12-bit	4x24-bit	v	v	up to 45	LQFP64
NUC120VE3AN	128 KB	16 KB	3	4	2	1	1	8	2	8x12-bit	4x24-bit	v	v	up to 76	LQFP100
NUC120VD3AN	64 KB	16 KB	3	4	2	1	1	8	2	8x12-bit	4x24-bit	v	v	up to 76	LQFP100
NUC120VD2AN	64 KB	8 KB	3	4	2	1	1	8	2	8x12-bit	4x24-bit	v	v	up to 76	LQFP100

NUC120 series USB Line Selection Guide (Low Density)

※ The followings are without PDMA

Part number	Flash	SRAM	Connectivity				I ² S	PWM	Comp.	ADC	Timer	RTC	ISP ICP	I/O	Package
			UART	SPI/SSI	I ² C	USB									
NUC120LD2AN	64 KB	8 KB	2	1	2	1	1	4	1	8x12-bit	4x24-bit	v	v	up to 31	LQFP48
NUC120LD1AN	64 KB	4 KB	2	1	2	1	1	4	1	8X12-Bit	4x24-bit	v	v	up to 31	LQFP48
NUC120LC1AN	32 KB	4 KB	2	1	2	1	1	4	1	8X12-Bit	4x24-bit	v	v	up to 31	LQFP48
NUC120RD2AN	64 KB	8 KB	2	2	2	1	1	4	2	8x12-bit	4x24-bit	v	v	up to 45	LQFP64
NUC120RD1AN	64 KB	4 KB	2	2	2	1	1	4	2	8X12-Bit	4x24-bit	v	v	up to 45	LQFP64
NUC120RC1AN	32 KB	4 KB	2	2	2	1	1	4	2	8X12-Bit	4x24-bit	v	v	up to 45	LQFP64



7 REVISION HISTORY

VERSION	DATE	PAGE/ CHAP.	DESCRIPTION
V1.0	-	-	Initial Issued
V1.4	November 19, 2009		1. Revise Pin-Assignment diagram 2. Revise Selection Guide
V1.6	December 23, 2009		Revise Selection Guide for low density series
V1.7	January 08, 2010		Add electrical characteristics spec
V1.8	January 22, 2010		Add I ² S feature and update pin diagram
V1.9.2	February 09, 2010		1. Add package dimension information 2. Fix SELECTION GUIDE typo
V1.10	February 10, 2010		Modify ADC specification