

8-bit Microcontroller

KM101EF93G Datasheet

The information described in this document is the exclusive intellectual property of Nuvoton Technology Corporation Japan and shall not be reproduced without permission from Nuvoton.

Nuvoton is providing document only for reference purposes of KM101EF93G based system design.

Nuvoton assumes no responsibility for errors or omissions. All data and specifications are subject to change without notice.

For additional information or question, please contact Nuvoton Technology Corporation Japan.

www.nuvoton.co.jp

1.1 Overview

1.1.1 Overview

The KM101E series of 8-bit single-chip microcomputers (the memory expansion version of KM101C series) incorporate multiple types of peripheral functions. This chip series is well suited for camera, TV, CD, printer, telephone, home appliance, PPC, fax machine, music instrument and other applications.

This LSI brings to embedded microcomputer applications flexible, optimized hardware configurations and a simple efficient instruction set. KM101EF93G have an internal 128 KB of ROM and 6 KB of RAM. Peripheral functions include 5 external interrupts, including NMI, 9 timer counters, 4 types of serial interfaces, A/D converter, watchdog timer and buzzer output. The system configuration is suitable for system control microcontroller.

With 3 oscillation systems (internal frequency: 16 MHz, high-speed crystal/ceramic frequency: max. 10 MHz, low-speed crystal/ceramic frequency: 32.768 kHz) contained on the chip, the system clock can be switched to high-speed frequency input (NORMAL mode) or PLL input (PLL mode), or low-speed frequency input (SLOW mode). The system clock is generated by dividing the oscillation clock or PLL clock. The best operation clock for the system can be selected by switching its frequency ratio by programming. High speed mode has NORMAL mode which is based on the clock dividing fpll, (fpll is generated by original oscillation and PLL), by 2 (fpll/2), and the double speed mode which is based on the clock not dividing fpll.

A machine cycle (minimum instruction execution time) in NORMAL mode is 200 ns when the original oscillation fosc is 10 MHz (PLL is not used). A machine cycle in the double speed mode, in which the CPU operates on the same clock as the external clock, is 100 ns when fosc is 10 MHz. A machine cycle in the PLL mode is 50 ns (maximum).

1.1.2 Product Summary

This manual describes the following model.

Table:1.1.1 Product Summary

Model	ROM Size	RAM Size	Classification	Package
KM101EF93G	128 KB	6 KB	Flash EEPROM version	80 Pin LQFP

1.2 Hardware Functions

■ Feature

- Memory Capacity:
 - ROM 128 KB
 - RAM 6 KB

- Package:
 - 80-Pin LQFP (14 mm × 14 mm / 0.65 mm pitch, halogen free)

Nuvoton "halogen free" semiconductor products refer to the products made of molding resin and interposer which conform to the following standards.

- Bromine : 900 ppm (Maximum Concentration Value)
- Chlorine : 900 ppm (Maximum Concentration Value)
- Bromine + Chlorine : 1500 ppm (Maximum Concentration Value)

The above-mentioned standards are based on the numerical value described in IEC61249-2-21. Antimony and its compounds are not added intentionally.

- Machine Cycle:
 - High-speed mode 0.05 μ s / 20 MHz (4.0 V to 5.5 V)
 - Low-speed mode 62.5 μ s / 32 kHz (4.0 V to 5.5 V)

- Oscillation circuit: 3 channel oscillation circuit
 - Internal oscillation (frc): 16 MHz
 - Crystal/ceramic (fosc): Maximum 10 MHz
 - Crystal/ceramic (fx): Maximum 32.768 kHz

- Clock Multiplication circuit (PLL Circuit)
 - PLL circuit output clock (fppll): fosc multiplied by 2, 3, 4, 5, 6, 8, 10,
1/2 × frc multiplication by 4, 5 enable

- Clock Gear for System Clock
 - System Clock (fs): fppll divided by 1, 2, 4, 16, 32, 64, 128

- Clock Gear for control clock of peripheral function
 - Control clock of peripheral function (fppll-div): stop or fppll divided by 1, 2, 4, 8, 16

- Memory Bank:
 - Expands data memory space by the bank system (by 64 KB, 16 banks)
 - Source address bank / Destination address bank

- Operation Mode:
 - NORMAL mode (High-speed mode)
 - SLOW mode (Low-speed mode)
 - HALT mode
 - STOP mode
 - (The operation clock can be switched in each mode.)

- Operating Voltage: 4.0 V to 5.5 V

- Operation ambient temperature: -40 °C to +85 °C

- Interrupt: 25 levels
 - <Non-maskable interrupt>
 - Non-maskable interrupt and Watchdog timer overflow interrupt

 - <Timer interrupts>
 - Timer 0 interrupt
 - Timer 1 interrupt
 - Timer 2 interrupt
 - Timer 3 interrupt
 - Timer 6 interrupt
 - Time base timer interrupt
 - Timer 7 interrupt
 - Timer 7 compare register 2 match interrupt
 - Timer 8 interrupt
 - Timer 8 compare register 2 match interrupt

 - <Serial Interface interrupts>
 - Serial interface 0 interrupt
 - Serial interface 0 UART reception interrupt
 - Serial interface 1 interrupt
 - Serial interface 1 UART reception interrupt
 - Serial interface 2 interrupt
 - Serial interface 2 UART reception interrupt
 - Serial interface 4 interrupt
 - Serial interface 4 stop condition interrupt

 - <A/D interrupt>
 - A/D conversion interrupt

 - <External interrupts>
 - IRQ0: Edge selectable, noise filter connection available
 - IRQ1: Edge selectable, noise filter connection available
 - IRQ2: Edge selectable, noise filter connection available, both edges interrupt
 - IRQ3: Edge selectable, noise filter connection available, both edges interrupt
 - IRQ4: Edge selectable, noise filter connection available, both edges interrupt, Key scan interrupt

- Timer Counter: 9 timers
 - 8-bit timer for general use × 4 sets
 - 16-bit timer for general use × 2 sets
 - 8-bit free-run timer × 1 set
 - Time base timer × 1 set
 - Baud rate timer × 1 set

- Timer 0 (8-bit timer for general use)
 - Square wave output (Timer pulse output)
 - Added pulse (2-bit) type PWM output can be output to large current pin TM0IOA
 - Event count
 - Simple pulse measurement

- Clock source
fpll-div, fpll-div/4, fpll-div/16, fpll-div/32, fpll-div/64, fpll-div/128, fs/2, fs/4, fs/8,
fx, External clock, Timer A output

Timer 1 (8-bit timer for general use)

- Square wave output (Timer pulse output) can be output to large current pin TM1IOA
- Event count
- 16-bit cascade connected (with Timer 0)
- Clock source
fpll-div, fpll-div/4, fpll-div/16, fpll-div/32, fpll-div/64, fpll-div/128, fs/2, fs/4, fs/8,
fx, External clock, Timer A output

Timer 2 (8-bit timer for general use)

- Square wave output (Timer pulse output)
- Added pulse (2-bit) type PWM output can be output to large current pin TM2IOA
- Event count
- Simple pulse measurement
- 24-bit cascade connected (with Timer 0 and Timer 1)
- Clock source
fpll-div, fpll-div/4, fpll-div/16, fpll-div/32, fpll-div/64, fpll-div/128, fs/2, fs/4, fs/8, fx,
External clock, Timer A output

Timer 3 (8-bit timer for general use)

- Square wave output (Timer pulse output) can be output to large current pin TM3IOA
- Event count
- 16-bit cascade connected (with Timer 2)
- 32-bit cascade connected (with Timer 0 and Timer 1 and Timer 2)
- Clock source
fpll-div, fpll-div/4, fpll-div/16, fpll-div/32, fpll-div/128, fs/2, fs/4, fs/8, fx,
External clock, Timer A output

Timer 6 (8-bit free-run timer, Time base timer)

8-bit free-run timer

- Clock source
fpll-div, fpll-div/2¹², fpll-div/2¹³, fs, fx, fx/2², fx/2³, fx/2¹², fx/2¹³

Time base timer

- Interrupt generation cycle
fpll-div/2⁷, fpll-div/2⁸, fpll-div/2⁹, fpll-div/2¹⁰, fpll-div/2¹³, fpll-div/2¹⁵, fx/2⁷, fx/2⁸, fx/2⁹, fx/2¹⁰,
fx/2¹³, fx/2¹⁵

Timer 7 (16-bit timer for general use)

- Square wave output (Timer pulse output)
- High precision PWM output (Cycle/Duty continuous changeable) can be output to large current pin
TM7IOA
- Event count
- Input capture function (Both edges can be operated)
- Clock source
fpll-div, fpll-div/2, fpll-div/4, fpll-div/16, fs, fs/2, fs/4, fs/16,
Timer A divided by 1, 2, 4, 16, External clock divided by 1, 2, 4, 16

Timer 8 (16-bit timer for general use)

- Square wave output (Timer pulse output)
- High precision PWM output (Cycle/Duty continuous changeable) can be output to large current pin

- TM8IOA
 - Event count
 - Input capture function (Both edges can be operated)
 - Clock source
 - fpll-div, fpll-div/2, fpll-div/4, fpll-div/16, fs, fs/2, fs/4, fs/16,
 - Timer A divided by 1, 2, 4, 16, External clock divided by 1, 2, 4, 16
- Timer A (Baud rate timer)
 - Clock output for peripheral functions
 - Clock source
 - fpll-div, fpll-div/2, fpll-div/4, fpll-div/8, fpll-div/16, fpll-div/32, fs/2, fs/4
- Watchdog timer
 - Time-out cycle can be selected from $fs/2^{16}$, $fs/2^{18}$, $fs/2^{20}$
 - On detection of 2 errors, forcibly hard reset inside LSI.
 - Operation start timing is selectable. (At reset release or write to register)
- Buzzer Output/ Reverse Buzzer Output
 - Output frequency can be selected from $fpll-div/2^9$, $fpll-div/2^{10}$, $fpll-div/2^{11}$, $fpll-div/2^{12}$, $fpll-div/2^{13}$, $fpll-div/2^{14}$, $fx/2^3$, $fx/2^4$
- A/D Converter: 10-bit × 12 channels
- Serial Interface: 4 channels
 - Serial 0: UART (full duplex)/ Clock synchronous
 - Clock synchronous serial interface
 - Transfer clock source fpll-div/2, fpll-div/4, fpll-div/16, fpll-div/64, fs/2, fs/4, Timer 0 to 3 or Timer A divided by 1, 2, 4, 8, 16, External clock
 - MSB/LSB can be selected as the first bit to be transferred, arbitrary sizes of 2 to 8 bits are selectable.
 - Sequence transmission, reception or both are available
 - Full duplex UART
 - Baud rate timer, selected from Timer 0 to 3 or Timer A
 - Parity check, overrun error/ framing error detection
 - Transfer size 7 to 8 bits can be selected
 - Serial 1: UART (full duplex)/ Clock synchronous
 - Clock synchronous serial interface
 - Transfer clock source fpll-div/2, fpll-div/4, fpll-div/16, fpll-div/64, fs/2, fs/4, Timer 0 to 3 or Timer A divided by 1, 2, 4, 8, 16, External clock
 - MSB/LSB can be selected as the first bit to be transferred, arbitrary sizes of 2 to 8 bits are selectable.
 - Sequence transmission, reception or both are available.
 - Full duplex UART
 - Baud rate timer, selected from Timer 0 to 3 or Timer A
 - Parity check, overrun error/ framing error detection
 - Transfer size 7 to 8 bits can be selected
 - Serial 2: UART (full duplex)/ Clock synchronous
 - Clock synchronous serial interface
 - Transfer clock source fpll-div/2, fpll-div/4, fpll-div/16, fpll-div/64, fs/2, fs/4, Timer 0 to 3 or Timer A divided by 1, 2, 4, 8, 16, External clock
 - MSB/LSB can be selected as the first bit to be transferred,

- arbitrary sizes of 2 to 8 bits are selectable.
 - Sequence transmission, reception or both are available.
- Full duplex UART
 - Baud rate timer, selected from Timer 0 to 3 or Timer A
 - Parity check, overrun error/ framing error detection
 - Transfer size 7 to 8 bits can be selected
- Serial 4: Multi master IIC/ Clock synchronous
 - Clock synchronous serial interface
 - Transfer clock source fpll-div/2, fpll-div/4, fpll-div/16, fpll-div/32, fs/2, fs/4, Timer 0 to 3 or Timer A divided by 1, 2, 4, 8, 16, External clock
 - MSB/LSB can be selected as the first bit to be transferred, arbitrary sizes of 2 to 8 bits are selectable.
 - Sequence transmission, reception or both are available.
 - Multi master IIC
 - 7-bit slave address is settable.
 - General call communication mode is supported.
- Automatic Reset:
 - Power detection level: 4.3 V (at rising), 4.2 V (at falling)
- LED Driver: 8 pins (Port A)
- Ports

I/O ports	72 pins
Serial Interface pins	21 pins
Timer I/O	11 pins
Buzzer output pins	2 pins
A/D input pins	12 pins
External Interrupt pins	5 pins
LED (large current) driver	8 pins
High-speed oscillation	2 pins
Low-speed oscillation	2 pins
Special pins	8 pins
Operation mode input pins	3 pins
Reset input pin	1 pin
Analog reference voltage input pin	1 pin
Power pins	3 pins

1.3 Pin Description

1.3.1 Pin configuration

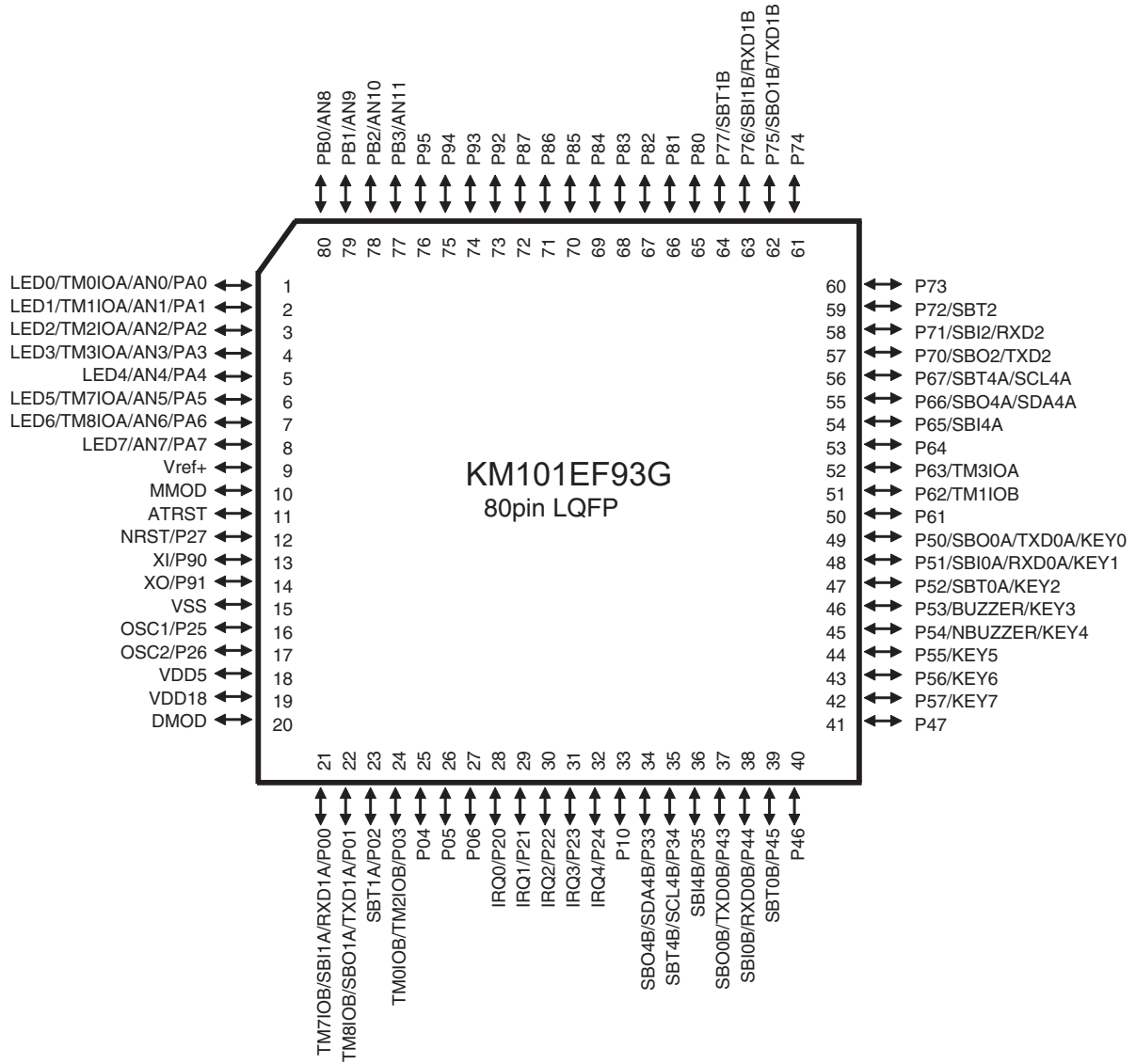

Figure:1.3.1 Pin Configuration (80-pin LQFP)

1.3.2 Pin Specification

Pins	Special Functions	I/O	Direction Control	Pin Control	Functions Description
P00	TM7IOB	in/out	P0DIR0	P0PLU0	Timer 7 input/output
	SBI1A	in/out			Serial 1 data input
	RXD1A	in/out			UART 1 data input
P01	TM8IOB	in/out	P0DIR1	P0PLU1	Timer 8 input/output
	SBO1A	in/out			Serial 1 data input/output
	TXD1A	in/out			UART 1 data input/output
	OCD_DATA	in/out			On-board programmer data pin
P02	SBT1A	in/out	P0DIR2	P0PLU2	Serial 1 clock input/output
	OCD_CLK	in/out			On-board programmer clock supply pin
P03	TM0IOB	in/out	P0DIR3	P0PLU3	Timer 0 input/output
	TM2IOB	in/out			Timer 2 input/output
P04	-	in/out	P0DIR4	P0PLU4	-
P05	-	in/out	P0DIR5	P0PLU5	-
P06	-	in/out	P0DIR6	P0PLU6	-
P10	-	in/out	P0DIR10	P0PLU10	-
P20	IRQ0	in/out	P2DIR0	P2PLU0	External Interrupt 0
P21	IRQ1	in/out	P2DIR1	P2PLU1	External Interrupt 1
P22	IRQ2	in/out	P2DIR2	P2PLU2	External Interrupt 2
P23	IRQ3	in/out	P2DIR3	P2PLU3	External Interrupt3
P24	IRQ4	in/out	P2DIR4	P2PLU4	External Interrupt4
P25	OSC1	in/out	P2DIR5	P2PLU5	Ceramic/crystal high-speed clock input
P26	OSC2	in/out	P2DIR6	P2PLU6	Ceramic/crystal high-speed clock output
P27	NRST	in/out	-	-	Reset
P33	SB04B	in/out	P3DIR3	P3PLU3	Serial 4 data input/output
	SDA4B	in/out			Multi-master IIC 4 data input/output
P34	SBT4B	in/out	P3DIR4	P3PLU4	Serial 4 clock input/output
	SCL4B	in/out			Multi-master IIC 4 clock input/output
P35	SBI4B	in/out	P3DIR5	P3PLU5	Serial 4 data input
P43	SBO0B	in/out	P4DIR3	P4PLU3	Serial 0 data input/output
	TXD0B	in/out			UART 0 data input/output
P44	SBI0B	in/out	P4DIR4	P4PLU4	Serial 0 data input
	RXD0B	in/out			UART 0 data input
P45	SBT0B	in/out	P4DIR5	P4PLU5	Serial 0 clock input/output
P46	-	in/out	P4DIR6	P4PLU6	-
P47	-	in/out	P4DIR7	P4PLU7	-
P50	KEY0	in/out	P5DIR0	P5PLU0	Key interrupt 0
	SBO0A	in/out			Serial 0 data input/output
	TXD0A	in/out			UART 0 data input/output
P51	KEY1	in/out	P5DIR1	P5PLU1	Key interrupt 1
	SBI0A	in/out			Serial 0 data input
	RXD0A	in/out			UART 0 data input

Pins	Special Functions	I/O	Direction Control	Pin Control	Functions Description
P52	KEY2	in/out	P5DIR2	P5PLU2	Key interrupt 2
	SBT0A	in/out			Serial 0 clock input/output
P53	KEY3	in/out	P5DIR3	P5PLU3	Key interrupt 3
	BUZZER	in/out			Buzzer output
P54	KEY4	in/out	P5DIR4	P5PLU4	Key interrupt 4
	NBUZZER	in/out			Buzzer reverse output
P55	KEY5	in/out	P5DIR5	P5PLU5	Key interrupt 5
P56	KEY6	in/out	P5DIR6	P5PLU6	Key interrupt 6
P57	KEY7	in/out	P5DIR7	P5PLU7	Key interrupt 7
P61	-	in/out	P6DIR1	P6PLU1	-
P62	TM1IOB	in/out	P6DIR2	P6PLU2	Timer 1 input/output
P63	TM3IOB	in/out	P6DIR3	P6PLU3	Timer 3 input/output
P64	-	in/out	P6DIR4	P6PLU4	-
P65	SBI4A	in/out	P6DIR5	P6PLU5	Serial 4 data input
P66	SBO4A	in/out	P6DIR6	P6PLU6	Serial 4 data input/output
	SDA4A	in/out			Multi-master IIC 4 data input/output
P67	SBT4A	in/out	P6DIR7	P6PLU7	Serial 4 clock input/output
	SCL4A	in/out			Multi-master IIC 4 clock input/output
P70	SBO2	in/out	P7DIR0	P7PLU0	Serial 2 data input/output
	TXD2	in/out			UART 2 data input/output
P71	SBI2	in/out	P7DIR1	P7PLU1	Serial 2 data input
	RXD2	in/out			UART 2 data input
P72	SBT2	in/out	P7DIR2	P7PLU2	Serial 2 clock input/output
P73	-	in/out	P7DIR3	P7PLU3	-
P74	-	in/out	P7DIR4	P7PLU4	-
P75	SBO1B	in/out	P7DIR5	P7PLU5	Serial 1 data input/output
	TXD1B	in/out			UART 1 data input/output
P76	SBI1B	in/out	P7DIR6	P7PLU6	Serial 1 data input
	RXD1B	in/out			UART 1 data input
P77	SBT1B	in/out	P7DIR7	P7PLU7	Serial 1 clock input/output
P80	-	in/out	P8DIR0	P8PLU0	-
P81	-	in/out	P8DIR1	P8PLU1	-
P82	-	in/out	P8DIR2	P8PLU2	-
P83	-	in/out	P8DIR3	P8PLU3	-
P84	-	in/out	P8DIR4	P8PLU4	-
P85	-	in/out	P8DIR5	P8PLU5	-
P86	-	in/out	P8DIR6	P8PLU6	-
P87	-	in/out	P8DIR7	P8PLU7	-
P90	XI	in/out	P9DIR0	P9PLU0	Ceramic/crystal low-speed clock input
P91	XO	in/out	P9DIR1	P9PLU1	Ceramic/crystal low-speed clock output
P92	-	in/out	P9DIR2	P9PLU2	-
P93	-	in/out	P9DIR3	P9PLU3	-
P94	-	in/out	P9DIR4	P9PLU4	-
P95	-	in/out	P9DIR5	P9PLU5	-

Pins	Special Functions	I/O	Direction Control	Pin Control	Functions Description
PA0	AN0	in/out	PADIR0	PAPLU0	Analog 0 input
	LED0	in/out			LED driving pin 0
	TM0IOA	in/out			Timer 0 input/output
PA1	AN1	in/out	PADIR1	PAPLU1	Analog 1 input
	LED1	in/out			LED driving pin 1
	TM1IOA	in/out			Timer 1 input/output
PA2	AN2	in/out	PADIR2	PAPLU2	Analog 2 input
	LED2	in/out			LED driving pin 2
	TM2IOA	in/out			Timer 2 input/output
PA3	AN3	in/out	PADIR3	PAPLU3	Analog 3 input
	LED3	in/out			LED driving pin 3
	TM3IOA	in/out			Timer 3 input/output
PA4	AN4	in/out	PADIR4	PAPLU4	Analog 4 input
	LED4	in/out			LED driving pin 4
PA5	AN5	in/out	PADIR5	PAPLU5	Analog 5 input
	LED5	in/out			LED driving pin 5
	TM7IOA	in/out			Timer 7 input/output
PA6	AN6	in/out	PADIR6	PAPLU6	Analog 6 input
	LED6	in/out			LED driving pin 6
	TM8IOA	in/out			Timer 8 input/output
PA7	AN7	in/out	PADIR7	PAPLU7	Analog 7 input
	LED7	in/out			LED driving pin 7
PB0	AN8	in/out	PBDIR0	PBPLU0	Analog 8 input
PB1	AN9	in/out	PBDIR1	PBPLU1	Analog 9 input
PB2	AN10	in/out	PBDIR2	PBPLU2	Analog 10 input
PB3	AN11	in/out	PBDIR3	PBPLU3	Analog 11 input

1.3.3 Pin Functions

Pins	NO	I/O	Function	Description
VDD5	18	-	Power connect pins	Apply 4.0 V to 5.5 V to VDD5 and 0 V connect 0.1 μ F + 1 μ F or larger bypass capacitor for internal power stabilization.
VSS	15	-		
VDD18	19	-	Internal power output pin	This pin is output 1.8 V from internal power circuit. Don't use the power supply to external device. For internal power circuit output stability, connect at least 0.1 μ F + 1 μ F one bypass capacitor between VDD18 and VSS.
OSC1	16	Input	High speed operation clock input pin	Connect these oscillation pins to ceramic or crystal oscillators for high-frequency clock operation. If the clock is an external input, connect it to OSC1 and leave OSC2 open. The chip will not operate with an external clock when using STOP mode.
OSC2	17	Output	High speed operation clock output pin	
NRST	12	I/O	Reset pin [Active low]	This pin resets the chip when power is turned on, is allocated as P27 and contains an internal pull-up resistor (Typ. 50 k Ω). Setting this pin low initialize the internal state of the device. Thereafter, setting the input to high releases the reset. The hardware waits for the system clock to stabilize, then processes the reset interrupt. If a capacitor is to be inserted between NRST and VSS, it is recommended that a discharge diode be placed between NRST and VDD5.
ATRST	11	input	Auto reset setting pin	Input "High" to enable auto reset function and "Low" to disable this function
P00	21	I/O	I/O port 0	7-bit CMOS tri-state I/O port. Each bit can be set individually as either an input or output by P0DIR register. A pull-up resistor for each bit can be selected individually by P0PLU register. At reset, the input mode is selected and pull-up resistor is disabled (high impedance).
P01	22			
P02	23			
P03	24			
P04	25			
P05	26			
P06	27			
P10	33	I/O	I/O port 1	1-bit CMOS tri-state I/O port. It can be set as either an input or output by P1DIR register. A pull-up resistor can be selected by P1PLU register. At reset, the input mode is selected and pull-up resistor is disabled (high impedance).
P20	28	I/O	I/O port 2	7-bit CMOS tri-state I/O port. Each bit can be set individually as either an input or output by P2DIR register. A pull-up resistor for each bit can be selected individually by P2PLU register. At reset, the input mode is selected and pull-up resistor is disabled (high impedance)
P21	29			
P22	30			
P23	31			
P24	32			
P25	16			
P26	17			
P27	12	input	input port 2	P27 has an N-channel open-drain configuration.
P33	34	I/O	I/O port 3	3-bit CMOS tri-state I/O port. Each bit can be set individually as either an input or output by P3DIR register. A pull-up resistor for each bit can be selected individually by P3PLU register. At reset, the input mode is selected and pull-up resistor is disabled (high impedance).
P34	35			
P35	36			
P43	37	I/O	I/O port 4	5-bit CMOS tri-state I/O port. Each bit can be set individually as either an input or output by P4DIR register. A pull-up resistor for each bit can be selected individually by P4PLU register. At reset, the input mode is selected and pull-up resistor is disabled (high impedance).
P44	38			
P45	39			
P46	40			
P47	41			

Pins	NO	I/O	Function	Description
P50	49	I/O	I/O port 5	8-bit CMOS tri-state I/O port. Each bit can be set individually as either an input or output by P5DIR register. A pull-up resistor for each bit can be selected individually by P5PLU register. At reset, the input mode is selected and pull-up resistor is disabled (high impedance).
P51	48			
P52	47			
P53	46			
P54	45			
P55	44			
P56	43			
P57	42			
P61	50	I/O	I/O port 6	7-bit CMOS tri-state I/O port. Each bit can be set individually as either an input or output by P6DIR register. A pull-up resistor for each bit can be selected individually by P6PLU register. At reset, the input mode is selected and pull-up resistor is disabled (high impedance).
P62	51			
P63	52			
P64	53			
P65	54			
P66	55			
P67	56			
P70	57	I/O	I/O port 7	8-bit CMOS tri-state I/O port. Each bit can be set individually as either an input or output by P7DIR register. A pull-up resistor for each bit can be selected individually by P7PLU register. At reset, the input mode is selected and pull-up resistor is disabled (high impedance).
P71	58			
P72	59			
P73	60			
P74	61			
P75	62			
P76	63			
P77	64			
P80	65	I/O	I/O port 8	8-bit CMOS tri-state I/O port. Each bit can be set individually as either an input or output by P8DIR register. A pull-up resistor for each bit can be selected individually by P8PLU register. At reset, the input mode is selected and pull-up resistor is disabled (high impedance).
P81	66			
P82	67			
P83	68			
P84	69			
P85	70			
P86	71			
P87	72			
P90	13	I/O	I/O port 9	6-bit CMOS tri-state I/O port. Each bit can be set individually as either an input or output by P9DIR register. A pull-up resistor for each bit can be selected individually by P9PLU register. At reset, the input mode is selected and pull-up resistor is disabled (high impedance).
P91	14			
P92	73			
P93	74			
P94	75			
P95	76			
PA0	1	I/O	I/O port A	8-bit CMOS tri-state I/O port. Each bit can be set individually as either an input or output by PADIR register. A pull-up resistor for each bit can be selected individually by PAPLU register. At reset, the input mode is selected and pull-up resistor is disabled (high impedance).
PA1	2			
PA2	3			
PA3	4			
PA4	5			
PA5	6			
PA6	7			
PA7	8			

Pins	NO	I/O	Function	Description
PB0	80	I/O	I/O port B	4-bit CMOS tri-state I/O port. Each bit can be set individually as either an input or output by PBDIR register. A pull-up resistor for each bit can be selected individually by PBPLU register. At reset, the input mode is selected and pull-up resistor is disabled (high impedance).
PB1	79			
PB2	78			
PB3	77			
SBO0A	49	Output	Serial interface transmission data output pins	Transmission data output pins for serial interface 0,1,2,4. The output configuration, either COMS push-pull or Nch open-drain can be selected in P0ODC, P3ODC, P4ODC, P5ODC, P6ODC and P7ODC registers. Pull-up resistor can be selected in P0PLU, P3PLU, P4PLU, P5PLU, P6PLU, and P7PLU registers. Select output mode in P0DIR, P3DIR, P4DIR, P5DIR, P6DIR, and P7DIR registers and set serial data output mode in serial mode register 1 (SC0MD1, SC1MD1, SC2MD1, SC4MD1). These can be used as normal I/O pins when serial interface is not used.
SBO0B	37			
SBO1A	22			
SBO1B	62			
SBO2	57			
SBO4A	55			
SBO4B	34			
SBI0A	48	Input	Serial interface reception data input pins	Reception data input pins for serial interface 0,1,2,4. Pull-up resistor can be selected in P0PLU, P3PLU, P4PLU, P5PLU, P6PLU and P7PLU registers. Select the output mode in P0DIR, P3DIR, P4DIR, P5DIR, P6DIR and P7DIR registers and select serial data input mode in serial mode register 1 (SC0MD1, SC1MD1, SC2MD1, SC4MD1). These can be used as normal I/O pins when serial interface is not used.
SBI0B	38			
SBI1A	21			
SBI1B	63			
SBI2	58			
SBI4A	54			
SBI4B	36			
SBT0A	47	I/O	Serial interface Clock I/O pins	Clock I/O pins for serial interface 0,1,2,4. The output configuration, either COMS push-pull or Nch open-drain can be selected in P0ODC, P3ODC, P4ODC, P5ODC, P6ODC and P7ODC registers. Pull-up resistor can be selected in P0PLU, P3PLU, P4PLU, P5PLU, P6PLU and P7PLU registers. Select clock I/O in P0DIR, P3DIR, P4DIR, P5DIR, P6DIR and P7DIR registers and serial mode register 1 (SC0MD1, SC1MD1, SC2MD1, SC4MD1) with the communication mode. These can be used as normal I/O pins when serial interface is not used.
SBT0B	39			
SBT1A	23			
SBT1B	64			
SBT2	59			
SBT4A	56			
SBT4B	35			
TXD0A	49	Output	UART transmission data output pins	In serial interface 0,1,2 in UART mode, this pin is configured as the transmission data output pin. The output configuration, either COMS push-pull or Nch open-drain can be selected in P0ODC, P4ODC, P5ODC, P6ODC and P7ODC registers. Pull-up resistor can be selected by P0PLU, P4PLU, P5PLU(D), P6PLU and P7PLU registers. Select the output mode in P0DIR, P4DIR, P5DIR, P6DIR and P7DIR registers and select serial data output mode in serial mode register 1 (SC0MD1, SC1MD1, SC2MD1). These can be used as normal I/O pins when serial interface is not used.
TXD0B	37			
TXD1A	22			
TXD1B	62			
TXD2	57			
RXD0A	48	Input	UART reception data output pins	In serial interface 0,1,2 in UART mode, this pin is configured as the reception data input pin. Pull-up resistor can be selected in P0PLU, P4PLU, P5PLU(D), P6PLU and P7PLU registers. Select the input mode in P0DIR, P4DIR, P5DIR, P6DIR and P7DIR registers and select serial input in serial mode register 1 (SC0MD1, SC1MD1, SC2MD1). These can be used as normal I/O pins when serial interface is not used.
RXD0B	38			
RXD1A	21			
RXD1B	63			
RXD2	58			
SDA4A	55	I/O	IIC data I/O pins	In serial interface 4 in IIC mode, this pin is configured as the data I/O pin. For the output configuration, select Nch open-drain in P3ODC and P6ODC register and set pull-up resistor in P3PLU and P6PLU register. Select the output mode in P0DIR register and P6DIR register select serial data I/O mode by serial mode register 1 (SC4MD1). These can be used as normal I/O pin when serial interface is not used.
SDA4B	34			
SCL4A	56	I/O	IIC clock I/O pins	In serial interface 4 in IIC mode, this pin is configured as the clock I/O pin. For the output configuration, select Nch open-drain in P0ODC and P6ODC register and set pull-up resistor by P0PLU and P6PLU register. Select the output mode at P0DIR register and P6DIR register select serial clock I/O mode in serial mode register 1 (SC4MD1). These can be used as normal I/O pin when serial interface is not used
SCL4B	35			

Pins	NO	I/O	Function	Description
TM0IOA	1	I/O	Timer I/O pins	Event counter clock input pin, timer output and PWM signal output pin for 8-bit timer 0 to 3. To use this pin as event clock input, configure it as input by P0DIR, P6DIR and PADIR register. In the input mode, pull-up resistor can be selected in P0PLU, P6PLU, and PAPLU registers. For timer output, PWM signal output, select the special function pin in P0OMD1, P0OMD2, P6OMD and PAOMD registers, and set to the output mode in P0DIR, P6DIR and PADIR registers. These can be used as normal I/O pins when Timer I/O pin is not used.
TM0IOB	24			
TM1IOA	2			
TM1IOB	51			
TM2IOA	3			
TM2IOB	24			
TM3IOA	4			
TM3IOB	52			
BUZZER	46	Output	Buzzer output pins	Piezoelectric buzzer driving pin. Buzzer output is available to Port 5. The driving frequency can be set in DLYCTR register. In order to select Buzzer output, select the special function pin in P5OMD register, and set P5DIR register to the output mode. At the same time, select Buzzer output in oscillation stabilization wait control register (DLYCTR). These can be used as normal I/O pins when Buzzer output is not used.
NBUZZER	45			
TM7IOA	6	I/O	Timer I/O pins	Event counter clock input pin, timer output and PWM signal output pin for 16-bit timer 7 and 8. To use this pin as event clock input, configure it as input with P0DIR and PADIR registers. In the input mode, pull-up resistor can be selected by P0PLU and PAPLU registers. For timer output, PWM signal output, select the special function pin in P0OMD1 and PAOMD registers, and set to the output mode in P0DIR and PADIR registers. These can be used as normal I/O pins when not used as timer I/O pins.
TM7IOB	21			
TM8IOA	7			
TM8IOB	22			
VREF+	9	-	A/D reference voltage input pin	Reference power supply pin for A/D converter. Normally, the values of $V_{REF+} = V_{DD5}$ is used.
AN0	1	input	Analog input pins	Analog input pins for 12-channel, 10-bit A/D converter. Select the analog input by PAIMD, PBIMD register. When not used for analog input, these pins can be used as normal input pins.
AN1	2			
AN2	3			
AN3	4			
AN4	5			
AN5	6			
AN6	7			
AN7	8			
AN8	80			
AN9	79			
AN10	78			
AN11	77			
IRQ0	28	Input	External interrupt	External interrupt input pins. Select the external interrupt input enable by IRQCNT register. The valid edge for IRQ0 to 4 can be selected with IRQnICR register. IRQ2 to 4 can be set at both edges at pin voltage level. When not used for interrupts, these can be used as normal input pins.
IRQ1	29			
IRQ2	30			
IRQ3	31			
IRQ4	32			
KEY0	49	Input	Key interrupt input pins	Input pins for KEY interrupt based on OR condition result of pin inputs. These can be set to key input pins by 1-bit with KEY interrupt control register (KEYT3_1IMD, KEY3_2_IMD). When not used for KEY input, these pins can be used as normal I/O pins.
KEY1	48			
KEY2	47			
KEY3	46			
KEY4	45			
KEY5	44			
KEY6	43			
KEY7	42			

Pins	NO	I/O	Function	Description
LED0	1	Output	LED drive pins	Large current output pins. Select the large current output by LED-CNT registers. When not used for LED output, these pins can be used as normal I/O pins.
LED1	2			
LED2	3			
LED3	4			
LED4	5			
LED5	6			
LED6	7			
LED7	8			
DMOD	20	Input	Mode switch input pins	Set always to V_{DD5} .
MMOD	10	Input	ROM area switch input pins at start	Set always to V_{SS} .



For the MMOD setup in rewriting the flash memory, refer to [Chapter Internal Flash Memory] of LSI User's Manual.

1.4 Block Diagram

1.4.1 Block Diagram

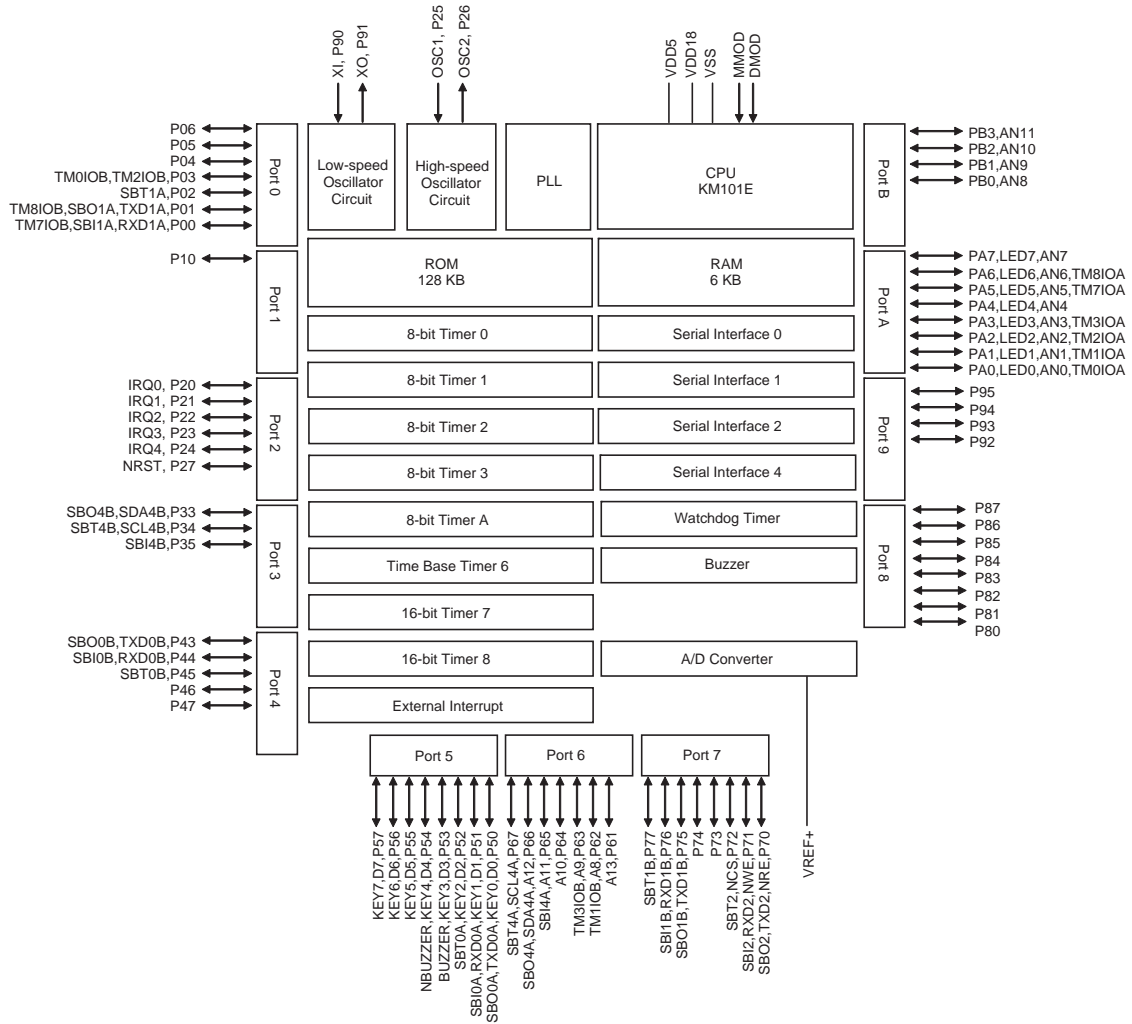

Figure:1.4.1 Block Diagram

1.5 Electrical Characteristics

When using this LSI, consult our sales offices for the product specifications.

Structure	CMOS integrated circuit
Application	General-purpose
Function	CMOS 8-bit single chip microcomputer

1.5.1 Absolute Maximum Ratings

A. Absolute Maximum Ratings *2 *3 *4

V_{SS} = 0 V

Parameter		Symbol	Rating	Unit
A1	Power supply voltage	V _{DD5}	-0.3 to +7.0	V
A2	Power supply voltage	V _{DD18}	-0.3 to +2.5	
A3	Input pin voltage	V _I	-0.3 to V _{DD5} +0.3 (upper limit: 7.0 V)	
A4	Output pin voltage	V _O	-0.3 to V _{DD5} +0.3 (upper limit: 7.0 V)	
A5	I/O pin voltage	V _{IO1}	-0.3 to V _{DD5} +0.3 (upper limit: 7.0 V)	
A6	Peak output current	LED output	I _{OL1} (peak)	mA
A7		Other than LED output	I _{OL2} (peak)	
A8		All pins	I _{OH} (peak)	
A9	Average output current *1	LED output	I _{OL1} (avg)	
A10		Other than LED output	I _{OL2} (avg)	
A11		All pins	I _{OH} (avg)	
A12	Power dissipation	P _D	400	mW
A13				
A14				
A15				
A16	Operating ambient temperature	T _{opr}	-40 to +85	°C
A17	Storage temperature	T _{STG}	-55 to +125	

*1 Applied to any 100 ms period.

*2 Connect at least one bypass capacitor of 0.1 μF + 1.0 μF or larger between VDD5 pin and GND for the internal power voltage stabilization.

*3 Connect appropriate capacitor about 0.1 μF + 1.0 μF between VDD18 pin and VSS pin, near the microcontroller according to the Figure:1.5.1 shown below for the internal power supply stabilization.

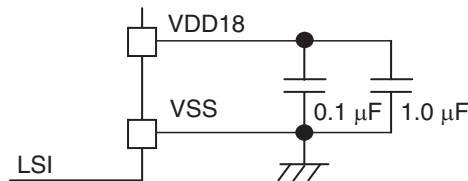

Figure:1.5.1 Capacitor Connection between VDD18 and VSS Pins

*4 The absolute maximum ratings are the limit values beyond which the LSI may be damaged.

1.5.2 Operating Conditions

B. Operating Conditions

$V_{SS} = 0\text{ V}$
 $T_a = -40\text{ °C to }+85\text{ °C}$

Parameter	Symbol	Conditions	Rating			Unit
			MIN	TYP	MAX	
Power supply voltage *5						
B1	Power supply voltage	V_{DD1}	4.0		5.5	V
B2	RAM retention power supply voltage	V_{DD2} During STOP mode	2.2		5.5	

Operating speed *6

B3	Instruction execution time f_s	t_{c1}	$V_{DD5} = 4.0\text{ V to }5.5\text{ V}$ (When ROMHND flag of HANDSHAKE register is "1".)	0.05		μs
B4		t_{c2}	$V_{DD5} = 4.0\text{ V to }5.5\text{ V}$ (When ROMHND flag of HANDSHAKE register is "0".)	0.10		
B5		t_{c3}	$V_{DD5} = 4.0\text{ V to }5.5\text{ V}$	61		

*5 f_s : Machine clock frequency

*6 t_{c1} to 2: when the machine clock is selected from external high-speed oscillation, internal high-speed oscillation, or both the oscillations multiplied by PLL.

External Oscillator 1 Figure:1.5.2

B6	Frequency	f_{hosc1}	V_{DD5} is within the specified operating power supply voltage range. (Refer to the ratings of B1 to B2 for the operating supply voltage range)	2.0		10	MHz
B7	Internal feedback resistor	R_{f10}	$V_{DD5} = 5.0\text{ V}$		980		$\text{k}\Omega$

External Oscillator 2 Figure:1.5.3

B8	Frequency	f_{sosc1}	$V_{DD5} = 4.0\text{ V to }5.5\text{ V}$		32.768		kHz
B9	Internal feedback resistor	R_{f20}	$V_{DD5} = 5.0\text{ V}$		6.2		$\text{M}\Omega$

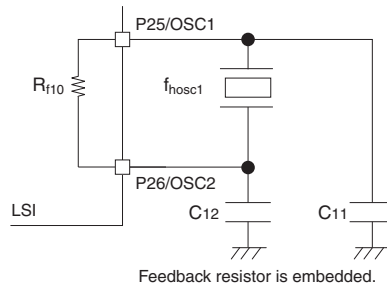

Figure:1.5.2 External Oscillator 1

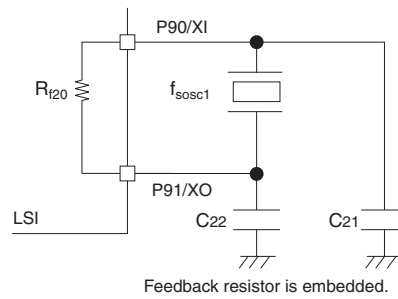

Figure:1.5.3 External Oscillator 2



Connect external capacitors suited for the used oscillator.
The reference value denotes external capacity value based on our matching result.
When crystal oscillator or ceramic oscillator is used, the oscillation frequency is changed depending on the value of capacitor. For external capacity value, please consult the oscillator manufacturer and perform matching tests enough for determining appropriate values.

$V_{DD5} = 4.0\text{ V to }5.5\text{ V}$
 $V_{SS} = 0\text{ V}$
 $T_a = -40\text{ }^\circ\text{C to }+85\text{ }^\circ\text{C}$

Parameter	Symbol	Conditions	Rating			Unit
			MIN	TYP	MAX	

External clock input 1 OSC1 (OSC2 is unconnected)

B10	Clock frequency	f_{hosc2}		2		10.0	MHz
B11	High-level pulse width *7	t_{wh1}	Figure:1.5.4	45			ns
B12	Low-level pulse width *7	t_{wl1}		45			
B13	Rising time	t_{wr1}	Figure:1.5.4	0		5.0	
B14	Falling time	t_{wf1}		0		5.0	

*7 The clock duty ratio should be 45 % to 55 %

External clock input 2 XI (XO is unconnected)

B15	Clock frequency	f_{sosc2}			32.768		kHz
B16	High-level pulse width *7	t_{wh2}	Figure:1.5.5		4.5		μs
B17	Low-level pulse width *7	t_{wl2}			4.5		μs
B18	Rising time	t_{wr2}	Figure:1.5.5	0		20	ns
B19	Falling time	t_{wf2}		0		20	ns

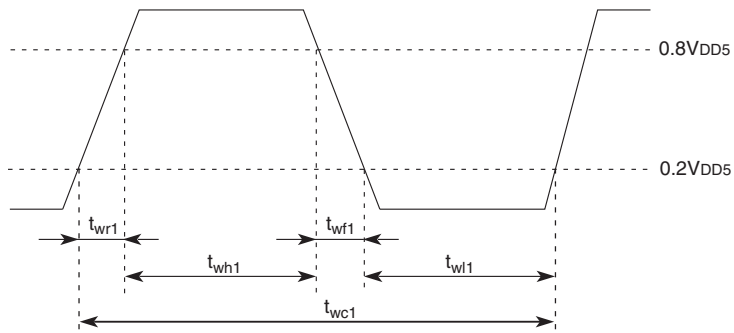

Figure:1.5.4 OSC1 Timing Chart

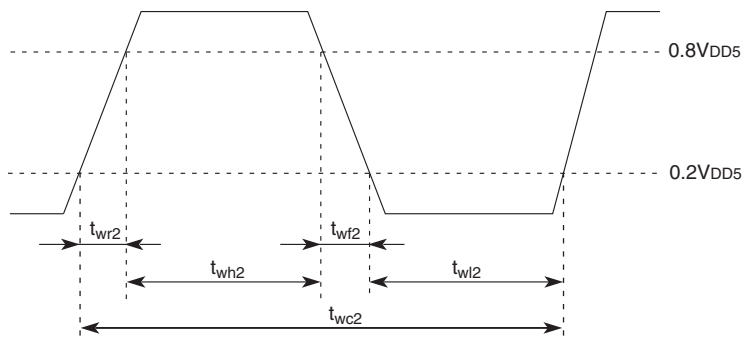

Figure:1.5.5 XI Timing Chart

1.5.3 DC Characteristics

C. DC Characteristics

$V_{SS} = 0\text{ V}$
 $T_a = -40\text{ }^\circ\text{C to } +85\text{ }^\circ\text{C}$

Parameter	Symbol	Conditions	Rating			Unit	
			MIN	TYP	MAX		
Power supply current *8							
C1	Power supply current during operation	I_{DD1}	$V_{DD5}=5\text{ V}$ $f_{osc}=10\text{ MHz}$ [Double-speed mode: $f_s=f_{osc}$] (PLL is not used) *9		5	14	mA
C2		I_{DD2}	$V_{DD5}=5\text{ V}$ $f_{osc}=10\text{ MHz}$ [Multiplied by 2, Divided by 2: $f_s=f_{osc}$] (PLL is used) *9		6	18	
C3		I_{DD3}	$V_{DD5}=5\text{ V}$ $f_{osc}=10\text{ MHz}$ [Multiplied by 2: $f_s=20\text{ MHz}$] (PLL is used) *9		9	20	
C4		I_{DD4}	$V_{DD5}=5\text{ V}$ $f_{rc}=16\text{ MHz}$ [Double-speed mode: $f_s=16\text{ MHz}$] (PLL is not used) *9		6	15	
C5	Power supply current during operation	I_{DD5}	$V_{DD5}=5\text{ V}$ $f_x=32.768\text{ kHz}$ [$f_s=f_x/2$]		200	400	μA
C6	Power supply current during STOP mode	I_{DD6}	$V_{DD5}=5\text{ V}$		145	245	μA

*8 Measured without loading (pull-up and pull-down resistors are not connected.)

To measure the power supply current during operation I_{DD1} to I_{DD4} :

1. Set all I/O pins to input mode,
2. Set the CPU mode to "NORMAL mode",
3. Fix pin MMOD to V_{SS} level and input pins to V_{DD5} level
4. Input the rectangular wave of 10 MHz with amplitude of V_{DD5} and V_{SS} , from pin OSC1.

To measure the power supply current during SLOW mode I_{DD5} :

1. Set all I/O pins to input mode
2. Set the CPU mode to "SLOW mode"
3. Fix the MMOD to V_{SS} level and input pins to V_{DD5} level

To measure the power supply current during STOP mode I_{DD6} :

1. Set the CPU mode to "STOP mode",
2. Fix pin MMOD to V_{SS} level and input pin to V_{DD5} level
3. Open pin OSC1.

*9 When ROMHND flag of HANDSHAKE register is set to "1"

$V_{DD5} = 4.0\text{ V to }5.5\text{ V}$ $V_{SS} = 0\text{ V}$
 $T_a = -40\text{ }^{\circ}\text{C to }+85\text{ }^{\circ}\text{C}$

Parameter	Symbol	Conditions	Rating			Unit
			MIN	TYP	MAX	

Input pin 1 ATRST, MMOD

C7	Input high voltage	V_{IH1}		$0.8V_{DD5}$		V_{DD5}	V
C8	Input low voltage	V_{IL1}		0		$0.2V_{DD5}$	
C9	Input leakage current	I_{LK1}	$V_{IN} = 0\text{ V to }V_{DD5}$			± 2	μA

Input pin 2 P27/NRST

C10	Input high voltage	V_{IH2}		$0.8V_{DD5}$		V_{DD5}	V
C11	Input low voltage	V_{IL2}		0		$0.15V_{DD5}$	
C12	Pull-up resistor	R_{RH2}	$V_{DD5}=5\text{ V}, V_{IN}=V_{SS}$	10	50	100	$\text{k}\Omega$

I/O pin 3

P00 to P06, P10, P20 to P26, P62 to P67, P70 to P77, P80 to P87

C13	Input high voltage	V_{IH3}		$0.8V_{DD5}$		V_{DD5}	V
C14	Input low voltage	V_{IL3}		0		$0.2V_{DD5}$	
C15	Input leakage current	I_{LK3}	$V_{IN}=0\text{ V to }V_{DD5}$			± 2	μA
C16	Pull-up resistor	R_{RH3}	$V_{DD5}=5.0\text{ V}, V_{IN}=V_{SS}$ Pull-up resistor ON	10	50	100	$\text{k}\Omega$
C17	Output high voltage	V_{OH3}	$V_{DD5}=5.0\text{ V}, I_{OH}=-0.5\text{ mA}$	4.5			V
C18	Output low voltage	V_{OL3}	$V_{DD5}=5.0\text{ V}, I_{OL}=1.0\text{ mA}$			0.5	

I/O pin 4 PA0 to PA7

C19	Input high voltage	V_{IH4}		$0.8V_{DD5}$		V_{DD5}	V
C20	Input low voltage	V_{IL4}		0		$0.2V_{DD5}$	
C21	Input leakage current	I_{LK4}	$V_{IN}=0\text{ V to }V_{DD5}$			± 2	μA
C22	Pull-up resistor	R_{RH4}	$V_{DD5}=5.0\text{ V}, V_{IN}=V_{SS}$ Pull-up resistor ON	10	50	100	$\text{k}\Omega$
C23	Output high voltage	V_{OH4}	$V_{DD5}=5.0\text{ V}, I_{OH}=-0.5\text{ mA}$	4.5			V
C24	Output low voltage 1	V_{OL41}	$V_{DD5}=5.0\text{ V}, I_{OL}=1.0\text{ mA}$ LED output OFF			0.5	
C25	Output low voltage 2	V_{OL42}	$V_{DD5}=5.0\text{ V}, I_{OL}=15.0\text{ mA}$ LED output ON			1.0	

$V_{DD5} = 4.0\text{ V to }5.5\text{ V}$ $V_{SS} = 0\text{ V}$
 $T_a = -40\text{ }^\circ\text{C to }+85\text{ }^\circ\text{C}$

Parameter	Symbol	Conditions	Rating			Unit
			MIN	TYP	MAX	

Input pin 5
P50 to P57, P90, P91, P94

C26	Input high voltage	V_{IH5}		$0.8V_{DD5}$		V_{DD5}	V
C27	Input low voltage	V_{IL5}		0		$0.2V_{DD5}$	
C28	Input leakage current	I_{LK5}	$V_{IN}=0\text{ V to }V_{DD5}$			± 2	μA
C29	Pull-up resistor	R_{RH5}	$V_{DD5}=5.0\text{ V, }V_{IN}=V_{SS}$ Pull-up resistor ON	10	50	100	k Ω
C30	Pull-down resistor	R_{RL5}	$V_{DD5}=5.0\text{ V, }V_{IN}=V_{DD5}$ Pull-down resistor ON	10	50	100	
C31	Output high voltage	V_{OH5}	$V_{DD5}=5.0\text{ V, }I_{OH}=-0.5\text{ mA}$	4.5			V
C32	Output low voltage	V_{OL5}	$V_{DD5}=5.0\text{ V, }I_{OL}=1.0\text{ mA}$			0.5	

Input pin 6 DMOD

C33	Input high voltage	V_{IH6}		$0.8V_{DD5}$		V_{DD5}	V
C34	Input low voltage	V_{IL6}		0		$0.2V_{DD5}$	
C35	Pull-up resistor	R_{RH6}	$V_{DD5}=5.0\text{ V, }V_{IN}=V_{SS}$ Pull-up resistor ON	10	50	100	k Ω

1.5.4 A/D Converter Characteristics

D. A/D Converter Characteristics *10

$V_{DD5} = 5.0\text{ V}$ $V_{SS} = 0\text{ V}$
 $T_a = -40\text{ }^\circ\text{C}$ to $+85\text{ }^\circ\text{C}$

Parameter	Symbol	Conditions	Rating			Unit
			MIN	TYP	MAX	
D1	Resolution				10	Bits
D2	Non-linearity error 1	$V_{DD5}=5.0\text{ V}$, $V_{SS}=0\text{ V}$			± 3	LSB
D3	Differential non-linearity error 1	$V_{REF+}=5.0\text{ V}$ $T_{AD}=800\text{ ns}$			± 3	
D4	Zero transition voltage	$V_{DD5}=5.0\text{ V}$, $V_{SS}=0\text{ V}$		10	30	mV
D5	Full-scale transition voltage	$V_{REF+}=5.0\text{ V}$ $T_{AD}=800\text{ ns}$	4970	4990		
D6	A/D conversion time	$T_{AD}=800\text{ ns}$	12.93			μs
D7	Sampling time	$T_{AD}=800\text{ ns}$	1.6			
D8	Reference voltage	V_{REF+} (Note)	4.0		V_{DD5}	V
D9	Analog input voltage		V_{SS}		V_{REF+}	
D10	Analog input leakage current	Channel OFF $V_{ADIN}=V_{SS}$ to V_{DD5}			± 2	μA
D11	Reference voltage pin input leakage current	Ladder resistance OFF $V_{SS} \leq V_{REF+} \leq V_{DD5}$			± 5	
D12	Ladder resistance	R_{LADD} $V_{DD5}=5.0\text{ V}$	15	40	80	$\text{k}\Omega$

*11 T_{AD} is A/D conversion clock cycle.
The specification values of D2 to D5 are guaranteed on the condition of $V_{DD5}=V_{REF+}=5\text{ V}$, $V_{SS}=0\text{ V}$.



Even if A/D function is not used, the voltage of V_{REF+} pin must be set between 4.0 V and V_{DD5} .

1.5.5 Auto Reset Characteristics

E. Auto Reset Characteristics

$V_{DD5} = V_{RST}$ to 5.5 V $V_{SS} = 0$ V
 $T_a = -40$ °C to +85 °C

Parameter	Symbol	Conditions	Rating			Unit	
			MIN	TYP	MAX		
Power supply voltage							
E1	Operating supply voltage	V_{DD7}	Auto reset is used	V_{RST}		5.5	V
Power supply voltage							
E2	Power detection level	V_{RST1}	At rising	4.10	4.30	4.50	V
E3	Power detection level	V_{RST2}	At falling	4.00	4.20	4.40	
E4	Supply voltage change rate	$\Delta t/\Delta V$		2			ms/V

1.5.6 Internal High-speed Oscillation Circuit

F. Internal High-speed Oscillation Circuit

$V_{DD5} = 4.0$ V to 5.5 V $V_{SS} = 0$ V

Parameter	Symbol	Conditions	Rating			Unit	
			MIN	TYP	MAX		
F1	Internal high-speed oscillation circuit frequency	f_{rc}	$T_a = -40$ °C to +85 °C		16		MHz
F2	Temperature dependence of oscillation frequency	f_{rc3}	$T_a = 25$ °C	-5.0		5.0	%
F3		f_{rc4}	$T_a = -40$ °C to +85 °C				

1.5.7 Flash EEPROM Program Conditions

G. Flash EEPROM Program Conditions

$V_{DD5} = 4.0\text{ V to }5.5\text{ V}$ $V_{SS} = 0\text{ V}^{*11}$

$T_a = -40\text{ }^{\circ}\text{C to }+85\text{ }^{\circ}\text{C}$

Parameter	Symbol	Conditions	Rating			Unit
			MIN	TYP	MAX	
G1 Programming supply voltage	V_{DDEW}		4.0		5.5	V
G2 Programming/Erasing times of 32KB, 20KB Sector *2	E_{MAX1}		1000			Times
G3 Programming/Erasing times of 4KB Sector *2	E_{MAX2}		10000			Times
G4 Data retention period of 32KB, 20KB Sector *1	T_{HOLD1}	$T_a = 85^{\circ}\text{C}$, P/E times ≤ 1000	20			Years
G5 Data retention period of 4KB Sector *1	T_{HOLD2}	$T_a = 85^{\circ}\text{C}$, P/E times ≤ 1000 *2	20			Years
	T_{HOLD3}	$T_a = 65^{\circ}\text{C}$, P/E times ≤ 10000 *2	20			Years

*1 Contain the period when power supply voltage is not supplied.

*2 Programming/Erasing times(P/E Times) is counted by the number of time a sector is erased. It is controlled on sector basis. For example, if writing 1 byte of data in any sector for hundred of times and then erasing the sector, a single rewriting is counted. Also, the number of times of rewriting in another sector, in which erasing is not performed, is not counted. Overwriting data is disabled. To rewrite data, write the data after erasing sectors.

1.6 Package Dimension

- Package code: LQFP080-P-1414E Unit: mm

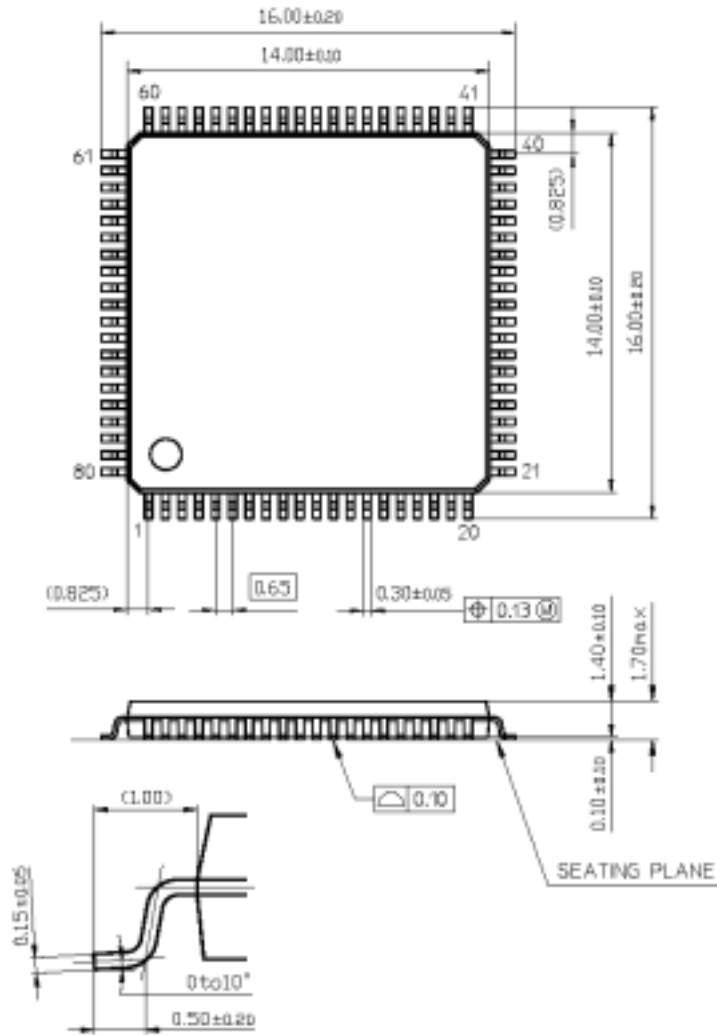

Figure:1.6.1 80-pin LQFP Package Dimension



This package dimension is subject to change. Before using this product, please obtain product specifications from our sales offices.

Important Notice

Nuvoton Products are neither intended nor warranted for usage in systems or equipment, any malfunction or failure of which may cause loss of human life, bodily injury or severe property damage. Such applications are deemed, “Insecure Usage”.

Insecure usage includes, but is not limited to: equipment for surgical implementation, atomic energy control instruments, airplane or spaceship instruments, the control or operation of dynamic, brake or safety systems designed for vehicular use, traffic signal instruments, all types of safety devices, and other applications intended to support or sustain life.

All Insecure Usage shall be made at customer’s risk, and in the event that third parties lay claims to Nuvoton as a result of customer’s Insecure Usage, customer shall indemnify the damages and liabilities thus incurred by Nuvoton.

*Please note that all data and specifications are subject to change without notice.
All the trademarks of products and companies mentioned in this datasheet belong to their respective owners.*